

**INSTRUCTION  
MANUAL**

# ATyS *p*

Automatic Transfer Switching Equipment

EN



[www.socomec.com](http://www.socomec.com)

To download, brochures, catalogues and technical manuals:



This manual is available for download in French, English, German, Italian, Spanish, Dutch, Portuguese, Russian, Polish, Turkish and Chinese.

<b>1. GENERAL SAFETY INSTRUCTIONS</b> .....	8
<b>2. INTRODUCTION</b> .....	9
<b>3. THE ATYS FAMILY PRODUCT RANGE</b> .....	10
3.1. THE ATYS RANGE KEY FEATURES .....	10
<b>4. QUICK START</b> .....	12
4.1. QUICK START ATYS P FRAME B3 TO B5 (125 A TO 630 A) .....	12
4.1. QUICK START ATYS P FRAME B3 TO B5 (125 A TO 630 A) CONTINUED .....	14
4.2. QUICK START ATYS P FRAME B6 TO B8 (800 A TO 3200 A) .....	16
4.2. QUICK START ATYS P FRAME B6 TO B8 (800 A TO 3200 A) CONTINUED .....	18
<b>5. GENERAL OVERVIEW</b> .....	20
5.1. PRODUCT INTRODUCTION.....	20
5.2. PRODUCT IDENTIFICATION .....	21
5.3. ATS CONTROL MODULE INTERFACE.....	22
5.4. ENVIRONMENTAL .....	23
5.4.1. IP RATING.....	23
5.4.2. OPERATING CONDITIONS .....	23
5.4.3. STORAGE CONDITIONS.....	23
5.4.4. VOLUME AND SHIPPING WEIGHTS BY REFERENCE ATYS P.....	24
5.4.5. CE MARKING.....	25
5.4.6. LEAD FREE PROCESS .....	25
5.4.7. WEEE.....	25
5.4.8. EMC STANDARD.....	25
5.5. ATYS P ACCESSORIES AVAILABLE .....	26
<b>6. INSTALLATION</b> .....	27
6.1. PRODUCT DIMENSIONS .....	27
6.1.1. DIMENSIONS: FRAME B3 TO B5 (125 A TO 630 A) .....	27
6.1.2. DIMENSIONS: FRAME B6 & B7 (800 A TO 1600 A).....	28
6.1.3. DIMENSIONS: FRAME B8 (2000 A TO 3200 A) .....	29
6.2. MOUNTING ORIENTATION.....	30
6.3. ASSEMBLY OF CUSTOMER MOUNTED ACCESSORIES.....	30
6.3.1. TERMINAL SHROUDS.....	30
6.3.2. TERMINAL SCREENS .....	30
6.3.3. BRIDGING BAR INSTALLATION.....	31
6.3.4. COPPER BAR CONNECTION KITS (2000 A TO 3200 A : FRAME B8).....	32
6.3.5. INCOMING COPPER BAR CONNECTION KIT ASSEMBLY .....	33
6.3.6. OUTGOING BRIDGE CONNECTION ASSEMBLY.....	33

6.3.7. EXTERNAL POWER SUPPLY (400 VAC - 230 VAC)	34
6.3.8. RAISED MOUNTING SPACERS	34
6.3.9. PADLOCKING KEY INTERLOCKS	35
6.3.10. ADDITIONAL AUXILIARY CONTACTS	35
6.4. ATYS P OPTIONAL MODULE INSTALLATION	36
<b>7. CONNECTIONS</b>	<b>37</b>
7.1. POWER CIRCUITS	37
7.1.1. CABLE OR BAR CONNECTIONS	37
7.1.2. POWER CONNECTION TERMINALS	37
7.1.3. POWER CONNECTION CROSS-SECTION	37
7.1.4. STANDARD CONNECTION PRIORITY SOURCE SUPPLY ON SWITCH I	38
7.1.5. SPECIFIC CONNECTION PRIORITY SOURCE SUPPLY ON SWITCH II	39
7.2. NETWORKS AND POWER CONNECTION POSSIBILITIES	40
7.2.1. TYPE OF NETWORKS	40
7.2.2. METERING AND SENSING DETAILS	41
7.3. CONTROL CIRCUITS	42
7.3.1. TYPICAL ATYS P WIRING	42
7.3.2. ATYS P INPUT AND OUTPUT CONTACTS	43
7.4. VOLTAGE SENSING AND POWER SUPPLY KIT	46
7.4.1. STANDARD CONFIGURATION	46
7.4.2. SENSING AND POWER SUPPLY KIT INSTALLATION (4 WIRE CONFIGURATION)	47
7.4.3. SENSING KIT WIRING DIAGRAM	47
7.4.4. SENSING KIT WIRING DIAGRAM (SPECIFIC)	48
<b>8. OPERATING MODES</b>	<b>51</b>
8.1. MANUAL OPERATION	52
8.1.1. EMERGENCY MANUAL OPERATION	52
8.1.2. PADLOCKING	52
8.2. ELECTRICAL OPERATION	53
8.2.1. DUAL POWER SUPPLY	53
8.2.2. VOLTAGE SENSING INPUTS	53
8.2.3. FIXED INPUTS	54
8.2.4. PROGRAMMABLE INPUTS	55
8.2.5. FIXED OUTPUTS - DRY CONTACTS	56
8.2.6. PROGRAMMABLE DRY CONTACT OUTPUT	59
<b>9. PROGRAMMING</b>	<b>60</b>
9.1. PROGRAMMING WITH EASY CONFIG SOFTWARE	60
9.1.1. DOWNLOAD AND INSTALL EASY CONFIG SOFTWARE	60
9.2. PROGRAMMING WITH THE ATYS P KEYPAD	62
<b>10. THE LCD DISPLAY</b>	<b>62</b>
10.1. PRESENTATION	62
10.2. DISPLAY MODE NAVIGATION AND VISUALISATION	63
10.3. IHM D10 / D20	63



<b>11. LOCAL / REMOTE CONTROL (POSITIONS I – 0 – II)</b> .....	64
<b>12. AUTOMATIC MODE</b> .....	64
12.1. MANUAL & AUTOMATIC MODE / MAINS RESTORATION CONDITIONS .....	64
12.2. PRIORITY SOURCE LOSS SEQUENCE M-G .....	65
12.3. PRIORITY SOURCE LOSS AND RESTORATION SEQUENCE M-M .....	66
12.4. PRIORITY SOURCE AUTOMATIC RESTORATION SEQUENCE .....	66
12.5. PRIORITY SOURCE RESTORATION SEQUENCE M-G .....	67
<b>13. TEST MODES</b> .....	68
13.1. TEST OFF LOAD .....	68
13.2. TEST ON LOAD .....	69
13.3. ENGINE EXERCISER (PERIODIC TEST) .....	69
<b>14. COMMUNICATION</b> .....	70
14.1. GENERAL INFORMATION .....	70
14.2. MODBUS® PROTOCOL .....	70
<b>15. PUTTING THE ATYS P INTO AUTO OPERATION</b> .....	71
<b>16. CHARACTERISTICS</b> .....	71
<b>17. PREVENTIVE MAINTENANCE</b> .....	74
<b>18. TROUBLE SHOOTING GUIDE</b> .....	74
18.1. EVENTS DISPLAY .....	76
<b>19. ACCESSORIES</b> .....	77
19.1. TERMINAL SHROUDS .....	77
19.2. TERMINAL SCREENS .....	77
19.3. BRIDGING BARS .....	77
19.4. COPPER BAR CONNECTION KITS .....	78
19.5. SOLID NEUTRAL .....	78
19.6. AUTOTRANSFORMER 400/230 VAC .....	79
19.7. DC POWER SUPPLY .....	79
19.8. VOLTAGE SENSING AND POWER SUPPLY KIT .....	79
19.9. VOLTAGE RELAY .....	79
19.10. DOOR PROTECTIVE SURROUND .....	80
19.11. AUXILIARY CONTACTS (ADDITIONAL) .....	80
19.12. MOUNTING SPACERS .....	80
19.13. 3 POSITION PADLOCKING (I - 0 - II) .....	80
19.14. RONIS KEY INTERLOCKING SYSTEM .....	80
19.15. CURRENT TRANSFORMERS .....	81

19.16. PLUG-IN OPTIONAL MODULES.....	.81
19.17. REMOTE INTERFACE .....	.82
19.18. CONNECTION CABLE FOR REMOTE INTERFACE .....	.82
19.19. AUTO/MANUAL KEY SELECTOR .....	.82
<b>20. SPARE PARTS .....</b>	<b>.83</b>
20.1. ELECTRONIC MODULE .....	.83
20.2. MOTORISATION MODULE.....	.83
20.3. POWER SECTION .....	.83
<b>21. ATYS FAMILY: ORDERING INFORMATION .....</b>	<b>.84</b>
<hr/>	
<b>ANNEXE I. PROGRAMMING WITH EASY CONFIG SOFTWARE.....</b>	<b>.87</b>
ANNEXE I - 1. GETTING STARTED – THE MAIN FUNCTIONAL KEYS.....	.88
ANNEXE I - 2. SELECTING THE ATYS P PRODUCT .....	.88
ANNEXE I - 3. STATUS AND CONTROL SCREEN .....	.89
ANNEXE I - 4. SETTING SCREEN .....	.89
ANNEXE I - 5. POWER MANAGEMENT SCREEN.....	.92
ANNEXE I - 6. TIMERS SCREEN .....	.93
ANNEXE I - 7. INPUT AND OUTPUT CONFIGURATION SCREEN .....	.95
ANNEXE I - 8. ENGINE EXERCISER SCREEN.....	.98
ANNEXE I - 9. SAVING THE CONFIGURED SETTINGS.....	.99
ANNEXE I - 10. EVENT RECORDING SCREEN.....	.99
ANNEXE I - 11. SUPER USER ADDED FUNCTIONALITY .....	.102
<hr/>	
<b>ANNEXE II. PROGRAMMING WITH THE ATYS P KEYPAD .....</b>	<b>.109</b>
ANNEXE II - 1. GETTING STARDED - SOFTWARE VERSION .....	.110
ANNEXE II - 2. KEYPAD OPERATIONAL MODES.....	.110
ANNEXE II - 3. KEYPAD PROGRAMMING - GENERAL INFORMATION .....	.111
ANNEXE II - 4. CONFIGURATION NAVIGATION SCREEN.....	.112
ANNEXE II - 5. PARAMETER MODIFICATIONS.....	.113
ANNEXE II - 6. SETUP MENU – KEYPAD NAVIGATION.....	.114
ANNEXE II - 7. VOLTAGE LEVELS MENU – KEYPAD NAVIGATION .....	.116
ANNEXE II - 8. FREQUENCY LEVELS MENU – KEYPAD NAVIGATION .....	.117
ANNEXE II - 9. POWER LEVELS MENU – KEYPAD NAVIGATION.....	.118
ANNEXE II - 10. TIMERS MENU – KEYPAD NAVIGATION .....	.118
ANNEXE II - 11. I/O MENU – KEYPAD NAVIGATION .....	.121
ANNEXE II - 12. COMMUNICATION MENU – KEYPAD NAVIGATION.....	.126
ANNEXE II - 13. DATE AND TIME – KEYPAD NAVIGATION .....	.127
ANNEXE II - 14. PULSE MODULE – KEYPAD NAVIGATION.....	.127

<b>ANNEXE III. MODBUS® COMMUNICATION ADDRESS AND DESIGNATION DETAILS.</b>	<b>129</b>
ANNEXE III - 1. METROLOGY AFFECTED BY CURRENT AND VOLTAGE TRANSFORMERS	130
ANNEXE III - 2. ENERGY	130
ANNEXE III - 3. METROLOGY NOT AFFECTED BY CURRENT AND VOLTAGE TRANSFORMERS	131
ANNEXE III - 4. INPUT/OUTPUT STATE	131
ANNEXE III - 5. NETWORK SETTING	132
ANNEXE III - 6. HOUR/DATE SETTING	132
ANNEXE III - 7. ETHERNET MODULE INTERFACE	132
ANNEXE III - 8. ACTION SYSTEM	133
ANNEXE III - 9. STATUS	133
ANNEXE III - 10. ENGINE EXERCISER - CUSTOM TIME RANGE STATUS.	135
ANNEXE III - 11. MEASUREMENT TABLE (NO CT/VT AFFECTED)	135
ANNEXE III - 12. ENERGIES AND TIME METERS	137
ANNEXE III - 13. TIMERS STATE	138
ANNEXE III - 14. OPTION MODULE STATE	139
ANNEXE III - 15. COMMANDS	140
ANNEXE III - 16. USER COMMANDS	141
ANNEXE III - 17. SETUP TIMER	141
ANNEXE III - 18. SETUP THRESHOLD FOR UPSTREAM VOLTAGES	142
ANNEXE III - 19. SETUP USER'S POWER THRESHOLD	143
ANNEXE III - 20. SETUP NETWORK	143
ANNEXE III - 21. SETUP INPUT/OUTPUT.	144
ANNEXE III - 22. COMMUNICATION SETTINGS.	157
ANNEXE III - 23. PRODUCT COUNTERS	158
ANNEXE III - 24. OUTPUT SET	158
ANNEXE III - 25. INPUT STATE	159
ANNEXE III - 26. SETUP PULSE AND 0/4-20MA OPTION MODULES.	160
ANNEXE III - 27. SETUP CUSTOM TIME	162
ANNEXE III - 28. CUSTOM TIME VALIDATE.	163

# 1. GENERAL SAFETY INSTRUCTIONS

- This manual provides instructions on safety, connections and operation of the ATyS p motorised changeover switch manufactured by SOCOMEC.
- Whether the ATyS p is sold as a loose product, as a spare, as an enclosed solution or as any other configuration, this device must always be installed and commissioned by qualified and experienced personnel, in line with the manufacturers recommendations, following good engineering practices and after having read and understood the details in the latest release of the relative product instruction manual.
- Maintenance on the product and any other associated equipment including but not limited to servicing operations must be performed by adequately trained and qualified personnel.
- Each product is shipped with a label or other form of marking including rating and other important specific product information. One must also refer to and respect markings on the product prior to installation and commissioning for values and limits specific to that product.
- Using the product outside the intended scope, outside SOCOMEC recommendations or outside the specified ratings and limits can cause personal injury and/or damage to equipment.
- This instruction manual must be made accessible so as to be easily available to anyone who may need to read it in relation with the ATyS p.
- The ATyS p meets the European Directives governing this type of product and includes CE marking on each product.
- No covers on the ATyS p should be opened (with or without voltage) as there may still be dangerous voltages inside the product such as those from external circuits.
- **Do not handle any control or power cables connected to the ATyS p when voltage may be present on the product directly through the mains or indirectly through external circuits.**
- Voltages associated with this product may cause injury, electric shock, burns or death. Prior to carry out any maintenance or other work on live parts or other parts in the vicinity of exposed live parts, ensure that the switch including all control and associated circuits are de-energized.

		
<b>DANGER</b>	<b>WARNING</b>	<b>CAUTION</b>
<b>RISK:</b> Electric shock, burns, death	<b>RISK:</b> Possible personal injury	<b>RISK:</b> Equipment damage

- As a minimum the ATyS p comply with the following international standards:
  - IEC 60947-6-1
  - GB 14048-11
  - EN 60947-6-1
  - VDE 0660-107
  - BS EN 60947-6-1
  - NBN EN 60947-6-1
  - IEC 60947-3
  - IS 13947-3
  - EN 60947-3
  - NBN EN 60947-3
  - BS EN 60947-3

The information provided in this instruction manual is subject to change without notice, remains for general information only and is non-contractual.



## 2. INTRODUCTION

ATyS p “Automatic Transfer Switching Equipment” (ATSE) is designed for use in power systems for the safe transfer of a load supply between a normal and an alternate source. The changeover is done in open transition and with minimum supply interruption during transfer ensuring full compliance with IEC 60947-6-1, GB 14048-11 and other international TSE standards as listed.

The ATyS p is a full load break (switch type) derived transfer switching equipment where the main components are proven technology devices also fulfilling requirements in IEC 60947-3 standards.

As a Class PC ATSE, the ATyS p is capable of “making and withstanding short circuit currents” assigned to IEC 60947-3 utilization categories of up to AC23A, GB 14048-11, IEC 60947-6-1 and equivalent standards with utilization categories of up to AC33B.

### ATyS p motorised source changeover switches ensure:

- Power Control and Safety between a normal and an alternate source.
  - A complete product delivered as a fully assembled and tested solution.
  - Intuitive HMI for emergency / local operation.
  - Integrated and robust switch disconnection.
  - Window with clearly visible position indication I – 0 - II.
  - An inherent failsafe mechanical interlock.
  - Stable positions (I – 0 – II) non affected by typical vibration and shocks.
  - Constant pressure on the contacts non effected by network voltage.
  - Energy Efficient with virtually no consumption whilst on the normal, alternate or off positions.
  - Quick, easy and safe dual “on-load” emergency manual operation.  
(Manual operation is functional with and without the motorization in place).
  - Extremely rugged, error free and built in padlocking facility.
  - Straight forward installation with effective ergonomics.
  - Minimal downtime with the possibility to perform easy maintenance.
  - Programmable secure motorization controls interface with remote control.
  - Up to 23 user configurable I/O with communication through MODBUS (Ethernet TCP or RS485) Optional
  - Webserver access to monitor most parameters available in the ATyS p.
  - Real time event recording with time stamp and export functionality.
  - Load power monitoring with Energy metering capability.
  - Engine exerciser for genset management applications.
  - ATS configuration through a keypad as well as through EasyConfig programming software.
  - Integrated auxiliary contacts for switch positions I – 0 - II.
  - Dual active “product availability” status feedback for motorisation and ATS controllers.
  - Ample accessories to suit specific requirements.
  - Fully integrated ATS controller specifically designed for Mains / Mains and Mains / Genset applications with power management and communication capabilities.
- Power supply continuity with power management and communication for most applications.

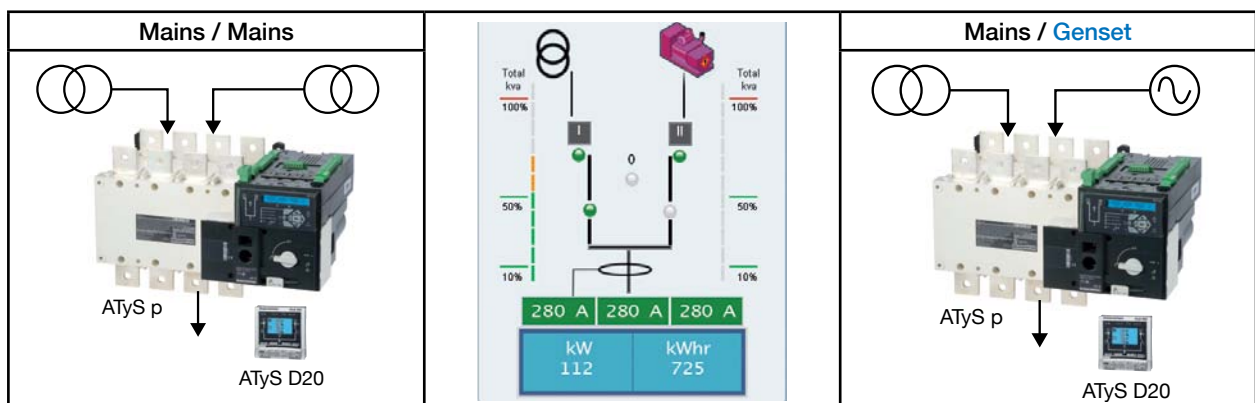

### 3. THE ATyS FAMILY PRODUCT RANGE

The ATyS p has been engineered by the SOCOMEC centre of excellence in France who boasts it's very own in-house 100MVA instantaneous power test lab accredited by COFRAC and working in partnership with: KEMA, CEPEC, UL, CSA, ASTA, Lloyd's Register of Shipping, Bureau Veritas, BBJ-SEP, EZU, GOST-R... and others.





SOCOMEC has been manufacturing power control and safety products since 1922. The first generation SOCOMEC "motorised changeover switches" were introduced in 1990 and today the ATyS brand has become trusted by major players in the power industry worldwide.

The ATyS Family includes a complete range of remotely operated transfer switch equipment (RTSE) as well as automatic fully integrated products and solutions (ATSE). Selecting the right ATyS will depend on the application as well as the nature of installation in which the ATyS will be installed.

This instruction manual includes details and instructions specific to the "ATyS p" ATSE only. For all other ATyS family of products please refer to the specific instruction manual related to that product. (Available for download on [www.socomec.com](http://www.socomec.com))

**An overview of the complete ATyS range is presented below:**  
*(The encircled device is the product detailed in this instruction manual).*

#### Just the right ATyS for your application...

ATyS: Small Footprint	ATyS M: Modular Profile
<p>Back to Back Configuration</p>  <p>125A - 3200A</p> <p><b>new</b></p>  <p>40A - 125A</p> <p><b>ATyS p</b> Power/Genset Management</p> <p><b>ATyS g</b> Simple Genset Management</p> <p><b>ATyS t</b> Transformer Management</p> <p><b>ATyS d S</b> Small Genset with DPS</p> <p><b>ATyS d</b> RTSE (DPS)</p> <p><b>ATyS S (RTSE)</b> Small Genset</p> <p><b>ATyS r</b> <sup>(1)</sup><b>ATyS</b>  RTSE RTSE</p>	 <p>40A - 160A</p> <p><b>ATyS p M</b> Evolved Genset Management</p> <p><b>ATyS g M</b> Simple Genset Management</p> <p><b>ATyS t M</b> Transformer (building) Management</p> <p><b>ATyS d M</b> RTSE (DPS)</p> <p>Side by Side Configuration</p>

<sup>(1)</sup> The UL version of ATyS r is available from 100 - 400 A

#### 3.1. The ATyS Range Key Features

Selecting the right ATyS will depend on the application, the functionality required as well as the nature of the installation in which the ATyS will be installed. Below is an outline product selection chart listing the key features of each product to help to select the right ATyS for your needs.

IEC 60947-6-1	ATyS S	ATyS Sd	ATyS r	ATyS d	ATyS t	ATyS g	ATyS p
UL 1008			ATyS 				
Motorised Changeover with control driven by dry contacts	•	•	•	•	•	•	•
Manual Emergency Operation with external handle	•	•	•	•	•	•	•
Wide band AC control voltage supply	•	•	•	•	•	•	•
Wide band DC control voltage supply	•						
Watchdog relay to ensure product availability			•	•	•	•	•
Ratings from 40 – 125 A as indicated or 125 A - 3200 A for •	40 – 125 A	40 – 125 A	UL 100 – 400 A	•	•	•	•
Override controls and force switch to zero (off) position			•	•	•	•	•
Integrated position auxiliary contacts (I - O - II)	•	•	•	•	•	•	•
Source availability LED display				•	•	•	•
Remote Display module RJ45 connection for D10				•	•	•	
Integrated Dual power supply		•		•	•	•	•
Network - Network Applications	•	•	•	•	•		•
Network - Genset Applications	•	•	•	•		•	•
Genset - Genset Applications	•	•	•	•			
Pre-defined fixed I/O			• 5/1	• 5/1	• 9/2	• 11/3	• 5/2
Programmable I/O							• 6/1
Additional programmable I/O modules (Optional up to 4 modules)							• 8/8
Remotely operated Transfer Switching Equipment (RTSE Class PC)	•	•	•	•			
Automatic Transfer Switching Equipment (ATSE Class PC)					•	•	•
Remote + Manual Control	•	•	•	•			
Auto + Remote + Manual Control					•	•	
Auto + Remote + Local + Manual Control							•
Auto-configuration of voltage and frequency levels					•	•	•
Switch Position LED display					•	•	•
Security Sealing Cover					•	•	
Configuration through potentiometers and dip switches					•	•	
Test on load functionality						•	•
Test off load functionality						•	•
Programmable configuration with keypad and LCD display							•
Metering & Measurement: kW; kVar; kVA + kWh; kVarh; kVAh							•
Communication RS485 + Ethernet + Ethernet gateway (Optional)							•
Webserver Access through optional Ethernet module (Optional)							•
Easy Configuration software (Through Ethernet/Modbus)							•
Remote Terminal Unit RJ45 connection for D20							•
Data Logger for Event Recording with RTC (Through Ethernet/Modbus)							•
Programmable Engine Exerciser functionality (Through Ethernet/Modbus)							•
Multi level password access							•
Load Shedding function							•
Capacity Management functionality							•
Peak shaving functionality							•
4 - 20mA communication module (Optional)							•
KWh Pulsed output module (Optional)							•
Counters KWh, permutation...							•
LCD display for programming, metering, timers and counters							•
Possibility to add optional functionality							•

# 4. QUICK START

## 4.1. Quick Start ATyS p Frame B3 to B5 (125 A to 630 A)



QUICK START EN 125A - 630A

# ATyS p

Motorised Source Changeover Switch  
Automatic Transfer Switching Equipment

### Preliminary operations

Check the following upon delivery and after removal of the packaging:

- Packaging and contents are in good condition.
- The product reference corresponds to the order.
- Contents should include:
  - Qty 1 x ATyS p
  - Qty 1 x Emergency handle and fixing clip
  - Quick Start instruction sheet

### Warning

**⚠ Risk of electrocution, burns or injury to persons and / or damage to equipment.**

This Quick Start is intended for personnel trained in the installation and commissioning of this product. For further details refer to the product instruction manual available on the SOCOMEC website.

- This product must always be installed and commissioned by qualified and approved personnel.
- Maintenance and servicing operations should be performed by trained and authorised personnel.
- Do not handle any control or power cables connected to the product when voltage may be, or may become present on the product, directly through the mains or indirectly through external circuits.
- Always use an appropriate voltage detection device to confirm the absence of voltage.
- Ensure that no metal objects are allowed to fall in the cabinet (risk of electrical arcing).

Failure to observe good engineering practises as well as to follow these safety instructions may expose the user and others to serious injury or death.

**⚠ Risk of damaging the device**

- In case the product is dropped or damaged in any way it is recommended to replace the complete product.

### Accessories

- Bridging bars and connection kits.
- Control voltage transformer (400Vac -> 230Vac).
- DC power supply (12/24Vdc -> 230Vac).
- Mounting spacers to raise the product x 10mm.
- Phase barriers.
- Terminal shrouds / Terminal screens.
- Auxiliary contacts (Additional).
- Padlocking in 3 positions (I - 0 - II).
- Lockout accessories (RONIS - EL 11 AP).
- Door escutcheon frame.
- ATyS D20 Interface (remote control / display unit).
- RJ45 cable for ATyS D20 => ATyS p.
- Voltage sensing kit.
- Current transformers.
- Plug-in optional modules: RS485 MODBUS communication, 2 inputs/2 outputs, Ethernet communication + RS485 JBUS/MODBUS gateway, Analogue outputs, Pulse outputs.

For further details refer to the product instruction manual under chapter "Spares and Accessories"



www.socomec.com

To download, brochures, catalogues and technical manuals:  
<http://www.socomec.com/en/documentation-atys-p>

Printing informations: 1 color Black. White paper 90g/m<sup>2</sup>.  
Printing size: 420x297. Final size 210x297. This page visible first.  
CORPORATE HQ CONTACT:  
SOCOMECSAS, 1-4 RUE DE WESTHOUSE, 67235 BENFELD, FRANCE



Non contractual document.  
Subject to change without notice.

### Installation and Commissioning

**STEP 1**  
Cabinet / Back Plate Installation

**STEP 2**  
Power Terminal Connections

**STEP 3**  
COMMAND / CONTROL terminal connections

**STEP 4**  
Power SUPPLY and ATS Controller Terminal Connections

**STEP 5**  
CHECK

**STEP 6**  
PROGRAMMING  
A - Software  
B - Keypad

**STEP 7A**  
AUT Mode  
(Automatic Control)

**STEP 7B**  
AUT Mode  
(Remote Control)

**STEP 7C**  
Manual Mode

**STEP 7D**  
Padlocking Mode

**STEP 4** Clip for storage of the emergency handle

**STEP 3**

**STEP 4** **Power Supply, Sensing and Control wiring (ATS Controller)**

Connect the product with a cable of section of 1,5 to 2,5 mm<sup>2</sup>.  
Screw M3 - Tightening torque: min.: 0.5 Nm - max.: 0.6 Nm

**ATS Power Supply Input II**  
Power supply II - L/N  
Power supply II - N/L  
208-277 VAC ±20%:  
50/60 Hz

**ATS Voltage Sensing Input Source supply II**  
S II - Phase / Neutral  
S I - Phase  
S II - Phase  
575 VAC (ph-ph) max  
S II - Neutral / Phase  
332 VAC (ph-n) max

**ATS Power Supply Input I**  
Power supply I - L/N  
Power supply I - N/L  
208-277 VAC ±20%:  
50/60 Hz

**Current Transformer incoming cable connections**

**Programmable Inputs**  
To opt. Module/Common  
Prog. Inputs (208-209)  
To opt. Module positive

**Slots for optional modules**  
See on the back "Optional modules"

**ATS Module Control Inputs (Programmable)**

**Genset Start/Stop Signal**  
NC  
Common  
NO

**ATS Module Output Contact (Programmable)**

**Remote interface RJ45 - to ATyS D20**

Recommended to use SOCOMEC Voltage Sensing Kit (refer to ATyS p accessories for details)

## STEP 1 Installation

Caution: Ensure that the product is installed on a flat rigid surface.

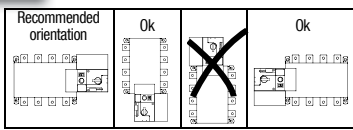

Door cut-out for front panel.

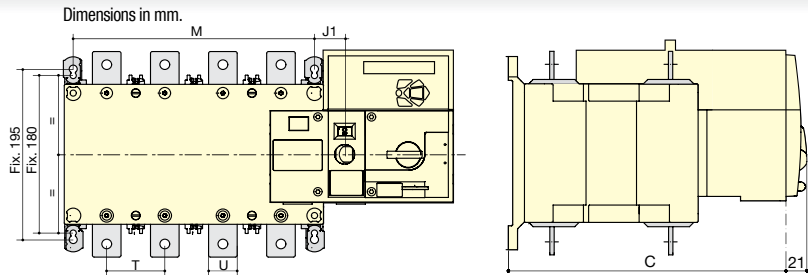
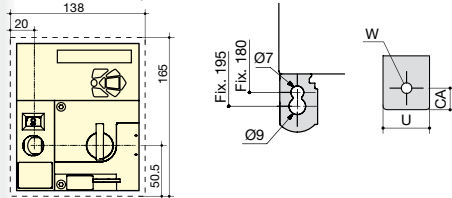

	125 A		160 A		200 A		250 A		315 A		400 A		500 A		630 A	
	3 P	4 P	3 P	4 P	3 P	4 P	3 P	4 P	3 P	4 P	3 P	4 P	3 P	4 P	3 P	4 P
J 1	34	34	34	34	34	34	35	35	35	35	35	35	34	34	34	34
M	120	150	120	150	120	150	160	210	160	210	160	210	210	270	210	270
T	36	36	36	36	36	36	50	50	50	50	50	50	65	65	65	65
C	244	244	244	244	244	244	244	244	244	244	244	244	320	320	320	320
U	20	20	20	20	20	20	25	25	35	35	35	35	32	32	45	45
W	9	9	9	9	9	9	11	11	11	11	11	11	13	13	13	13
CA	10	10	10	10	10	10	15	15	15	15	15	15	20	20	20	20

## STEP 2 Power Terminal Connections

To be connected using terminal lugs, rigid or flexible busbars.

	FRAME B3			FRAME B4			FRAME B5	
	125 A	160 A	200 A	250 A	315 A	400 A	500 A	630 A
Minimum cable section Cu (mm <sup>2</sup> ) at lth (IEC 60947-1)	35	35	50	95	120	185	2x95	2x120
Recommended cable section Cu (mm <sup>2</sup> ) at lth	-	-	-	-	-	-	2x30x5	2x40x5
Maximum cable section Cu (mm <sup>2</sup> )	50	95	120	150	240	240	2x185	2x300
Maximum Cu busbar width (mm)	25	25	25	32	32	32	50	50
Type of screw	M8	M8	M8	M10	M10	M10	M12	M12
Recommended tightening torque (N.m)	8.3	8.3	8.3	20	20	20	40	40
Maximum tightening torque (N.m)	13	13	13	26	26	26	45	45

Example: Control wiring for a 400VAC application having a 3 phase and neutral supply.

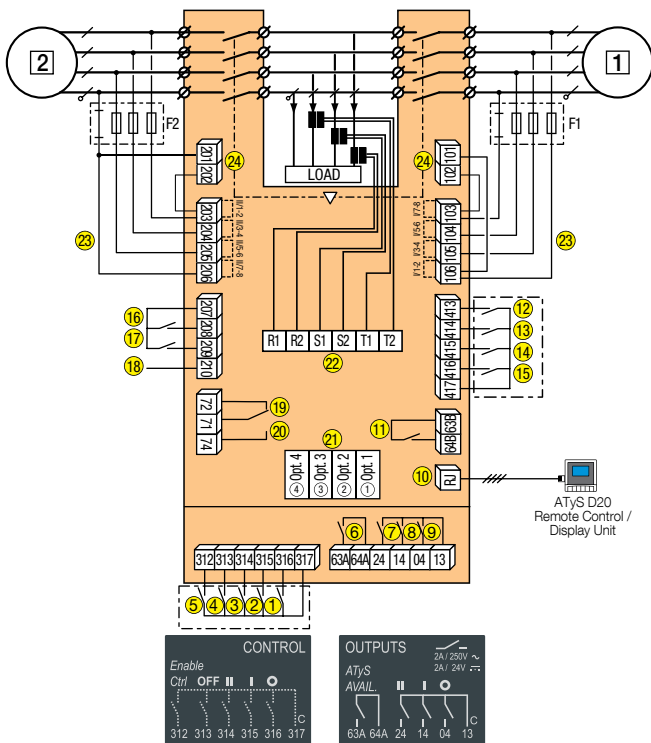

## STEP 3 CONTROL / COMMAND Terminals

Ensure that the product is in Manual Mode.

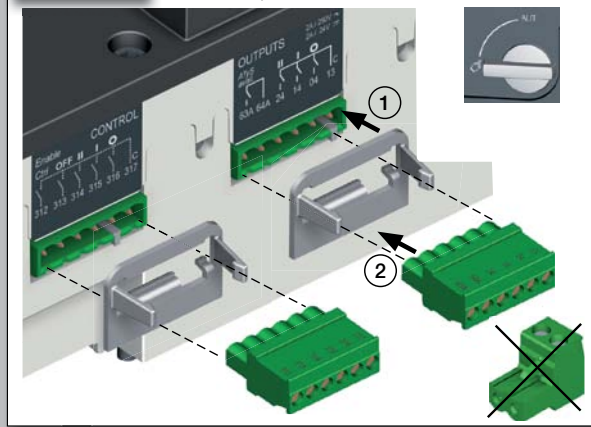

- 1 preferred source 2 alternate source
- 1-15. Programmable Inputs 1-4
- 16-17. Programmable Inputs 5-6
18. Aux. Supply (207/210) to be used with ATyS optional I/O modules
19. Contact "Start/Stop Genset" : if S1 is not available the NC contact le contact (71-72) is close
20. Contact "Start/Stop Genset" : if S1 is not available the NO contact le contact (71-74) is open
21. Option Module Slots 1 to 4
22. Current Transformer incoming cable connections
23. Voltage Sensing Inputs
24. Power Supply Inputs

# 4.1. Quick Start ATyS p Frame B3 to B5 (125 A to 630 A) continued

### STEP 5

**Check**  
Whilst in manual mode, check the wiring and if ok power up the product.

LED "Power" Green: ON  
LED Manual/Fault Red: ON

### Optional Modules

Communication between the software and the ATyS p may be done through the Ethernet/Modbus TCP or Modbus RTU modules that are available as an option. The ETHERNET / MODBUS modules are to be installed in one of the slots provided in the ATyS p ATS control unit.

Easy Config may be used with a PC connected or through ETHERNET or MODBUS modules as well as isolated from the product and simply saved on a PC for download at any convenient time.

**Note:** The ATyS p may accept a total of 4 additional Input / Output modules offering an additional 8 programmable inputs and 8 programmable outputs. When including a MODBUS module the ATyS p accepts a total of 3 I/O modules and when including the ETHERNET module a total of 2 I/O modules.

Refer to the ATyS p accessory section for details.

### STEP 6 Programming the ATyS p

The ATyS p is to be programmed powered up and after wiring verification tests. This may either be done through the front of the ATS Controller using the keypad or with the user-friendly Easy Config software.

For convenience, we recommend to use the Easy Config software. (Downloadable free from www.socomec.com).

The ATyS p is delivered with default setting values based on most used customer application requirements. The minimum configuration parameters that must be programmed are the type of network and application together with the voltage and frequency nominal values. ATyS p Auto Configuration makes the setup of Volts, Hz, Phase rotation and Neutral Position quick and easy.

#### A - Programming with Easy Config Software

To program the ATyS p using Easy Config software simply follow the setting boxes from left to right until all desired settings in each window have been completed. Help pop ups are included to show the minimum and maximum setting values allowed. The software includes most SOCOMEC products so before programming click NEW and select the product "ATyS p" from the list of products available.

When the ATyS p is powered and communicating, the software will include a screen to monitor and display the ATyS p status.

Control through software (such as changing switch position I-O-II) is also possible when in Super User Mode.

The Ethernet module includes a built in Web Server for Monitoring, Engine Exerciser Control, Events...

#### B - Programming with the ATyS p keypad

1 SETUP	2 VOLT. LEVELS	3 FREQ. LEVELS	4 PWR. LEVELS	5 TIMERS VALUE	6 I-O	7 COMM	8 DATE/TIME
NETWORK 4NBL	OV. U I 115%	OV. F I 105%	OV.P I 0000 KVA	1FT 0003 SEC	IN 1 --- NO	DHCP NO (9)	YEAR
AUTOCONF NO (7)	OV. U HYS I 110%	OV. F HYS I 103%	OV.P HYS I 0000 KVA	1RT 0180 SEC	IN 2 --- NO	IP 1-2 192.168.	MONTH
NEUTRAL AUTO	UND. U I 085%	UND. F I 095%	OV.P II 0000 KVA	2FT 0003 SEC	IN 3 --- NO	IP 3-4 .002.001 (9)	DAY
ROT PH. ---	UND. U HYS I 095%	UND. F HYS I 097%	OV.P HYS II 0000 KVA	2RT 0005 SEC (2)	IN 4 --- NO	GAT1-2 000.000.	HOUR
NOM. VOLT 400 V	UNB. U I 00%	OV. F II 105%	(1) When +APP+ is set to -M-G-	2AT 0005 SEC (1)	IN 5 --- NO	GAT3-4 .000.000 (9)	MINUTE
NOM. FREQ 50 Hz	UNB. U HYS I 00%	OV. F HYS II 103%	(2) When +APP+ is set to -M-M-	2CT 0180 SEC (1)	IN 6 --- NO	MSK1-2 255.255.	SECOND
APP M-G	OV. U II 115%	UND. F II 095%	(3) When one of the IP is set to +EON-	2ST 0030 SEC (1)	IN 7 --- NO (8)	MSK3-4 .255.000 (9)	
PRIO TON NO (1)	OV. U HYS II 110%	UND. F HYS II 097%	(4) When one of the O/P is set to +EOP-	ODT 0003 SEC	IN 8 --- NO (8)	ADDRESS 005	
PRIO EON NO (3)	UND. U II 085%		(5) When one of the O/P is set to +EES-	TOT UNL (1)	IN 9 --- NO (8)	BDRATE 9600	
PRIO NET 1 (2)	UND. U HYS II 095%		(6) If the product is in manual mode	TOT 0010 SEC (1)	IN10 --- NO (8)	STOP BIT 1	
RETRANS NO	UNB. U II 00%		(7) With optional I/O modules	T3T 0000 SEC (1)	IN11 --- NO (8)	PARITY NONE	
CT PRI 100	UNB. U HYS II 00%		(8) With Ethernet module	TFT UNL (1)	IN12 --- NO (8)		
CT SEC 5				TFT 0600 SEC (1)	IN13 --- NO (8)		
S1=SW2 NO				E1T 0005 SEC (3)	IN14 --- NO (8)		
BACKLGHNT INT				E2T UNL (3)	OUT 1 POP NO		
CODE P 1000				E2T 0010 SEC (3)	OUT 2 --- NO (8)		
CODE E 0000				E3T 0005 SEC (3)	OUT 3 --- NO (8)		
BACKUP SAVE				E5T 0005 SEC (4)	OUT 4 --- NO (8)		
				E6T LIM (4)	OUT 5 --- NO (8)		
				E6T 0600 SEC (4)	OUT 6 --- NO (8)		
				E7T 0005 SEC (4)	OUT 7 --- NO (8)		
				LST 0004 SEC (5)	OUT 8 --- NO (8)		
				EET 0168 H (6)	OUT 9 --- NO (8)		
				EDT 1800 SEC (6)			

ATyS p devices may also be programmed through the ATS controller keypad. This programming method is necessary for products not equipped with Ethernet or Modbus communication modules that facilitate programming through Easy Config software described above. The keypad is a useful interface and programming method most especially when changing a few parameters or simply interrogating the product.

**Programming access:** Press and hold for 5 s "Validation" push button (17). Access through the keypad is possible in Automatic or Manual mode, when the product is in a stable position (I, 0 or II) with at least one supply source available. Programming is not accessible whilst any cycle sequence is running.

**To change the configuration:** Enter code (factory code = 1000) using navigation push buttons (14).

**Programming exit:** Press and hold for 5 s "Validation" push button (17).

**Note 1:** Values as listed above are the setting values by default.

**Note 2:** Ensure that the Default Network Setting and Application match the installation or change accordingly before using Auto Configuration.

3 phase / 4 wire	3 phase / 3 wire	2 phase / 3 wire	2 phase / 2 wire	1 phase / 2 wire
4NBL 4BL	3NBL 3BL	2NBL	2BL	1BL

#### Setup by Auto Configuration

(Volts, Hz, Neutral pos., Ph rotation)

Press 5s	[Validation]
Go To	1 SETUP
Scroll to	AUTOCONF
Enter code	1000
Set to	YES
Press 60 ms	[Validation]
LEDs flash	[Green LEDs]
Save : press 5s	[Validation]

**Note:** Source I or source II must be available to set by Auto Configuration.

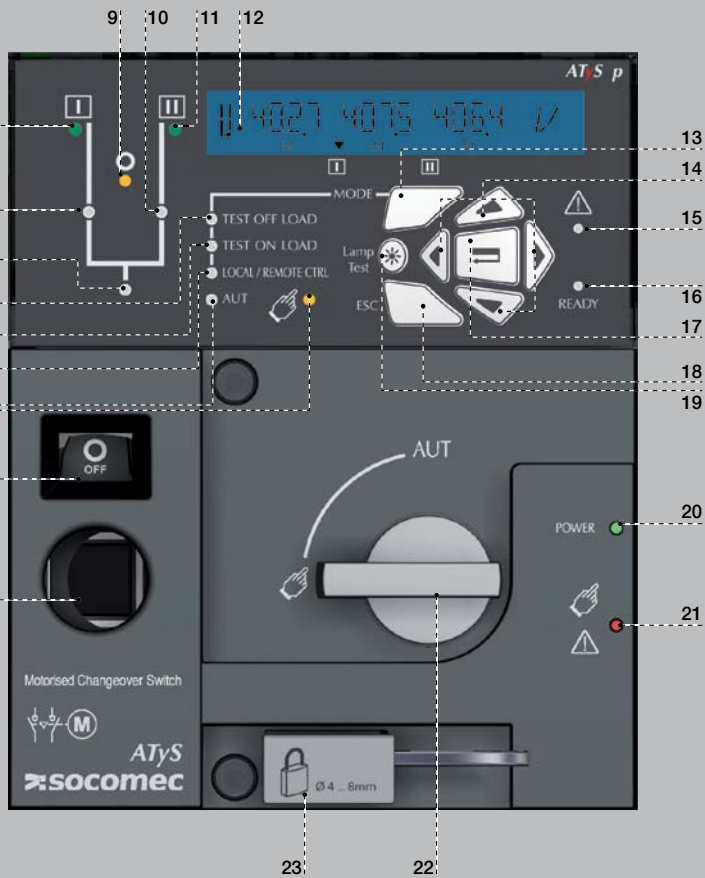

1. MANUAL Mode LED indication. (Yellow steady light when in Manual Mode).
2. AUTO Mode LED indication Green steady light when in Auto mode with no timers running. Green flashing light when in Auto with timers running.
3. LOCAL / REMOTE CONTROL Mode LED indication. Yellow steady light when in Local / Remote control mode. Remote control mode is achieved with the Auto/Manu selector switched to Auto and terminals 312 closed with terminal 317. Remote control orders are received through closing 314 to 316 with 317. REMOTE Control is also achievable through Easy Config ATyS p software when connected to the product through Ethernet or MODBUS. (Optional modules). Local Control selectable and operable through the ATyS p keypad.
4. TEST ON LOAD CONTROL Mode LED indication. (Yellow steady light when in TON/ EON mode)
5. TEST OFF LOAD CONTROL Mode LED indication. (Yellow steady light when in TOF/ EOF mode).
6. Load Supply On LED. (Green when the load is supplied).
7. Switch 1 LED position indication. (Green when in position 1).
8. Source supply I availability LED indication. (Green when supply I voltage is within the set limits).
9. Zero position LED indication. (Yellow when in position 0).
10. Switch 2 LED position indication. (Green when in position 2).
11. Source supply II availability LED indication. (Green when supply II voltage is within the set limits).
12. LCD Display Screen : (Status, measurement, timers, counters, events, faults, programming ....)
13. MODE key to shift between operation modes.
14. Navigation Keys to browse through the ATyS p menus without software.
15. FAULT LED indication. (Red steady light in case of an ATS controller internal fault. Switch the product from Auto to Manual and back to Auto to reset a fault condition).
16. READY LED indication. (Green steady light : Product is powered and in AUTO, Watchdog OK, The Product is Available to changeover).
17. Enter Key used to enter Prog Mode (Press and hold for 5 seconds) and to validate the settings programmed through the keypad.
18. ESC key used to escape from a specific screen up to the main menu.
19. Lamp test key to check the LED's and LCD screen.
20. Green LED Indication: Power
21. Red LED Indication: Product Unavailable / Manual Mode / Fault Condition
22. Auto / Manual mode selector switch (Key version available as an option)
23. Padlocking facility (Up to 3 padlocks of dia. 4 - 8mm)
24. Emergency manual operation shaft location (Accessible only in manual mode)
25. Switch position indication window: I (On switch I) O (Off) II (On switch II).

### STEP 7A

#### AUT Mode (Automatic Control)

Ensure that the emergency handle is not inserted in the product and turn the mode selector to the AUT position. LED "Power" Green: ON  
LED Manual/Default: OFF

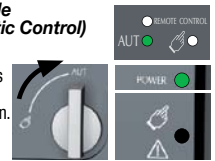

### STEP 7B

#### AUT Mode (Remote Control)

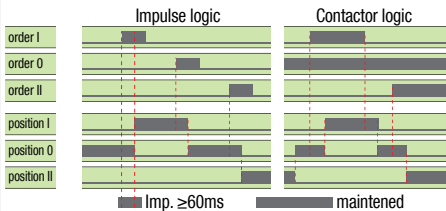

To enable control, close contact 312 with 317. For contactor logic bridge contact 316 with 317. To operate: close the contact corresponding to the desired position. To force the product to 0 position "OFF" bridge contact 313 with 317.

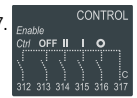

### STEP 7C

#### Manual Mode

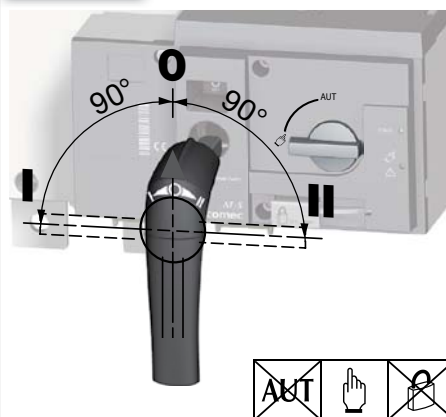

### STEP 7D

#### Padlocking Mode (as standard: in position 0)



## 4.2. Quick Start ATyS p Frame B6 to B8 (800 A to 3200 A)



QUICK START EN 800A - 3200A

# ATyS p

Motorised Source Changeover Switch  
Automatic Transfer Switching Equipment

### Preliminary operations

Check the following upon delivery and after removal of the packaging:

- Packaging and contents are in good condition.
- The product reference corresponds to the order.
- Contents should include:
  - Qty 1 x ATyS p
  - Qty 1 x Emergency handle and fixing clip
  - Quick Start instruction sheet

### Warning

**⚠ Risk of electrocution, burns or injury to persons and / or damage to equipment.**

This Quick Start is intended for personnel trained in the installation and commissioning of this product. For further details refer to the product instruction manual available on the SOCOMEC website.

- This product must always be installed and commissioned by qualified and approved personnel.
- Maintenance and servicing operations should be performed by trained and authorised personnel.
- Do not handle any control or power cables connected to the product when voltage may be, or may become present on the product, directly through the mains or indirectly through external circuits.
- Always use an appropriate voltage detection device to confirm the absence of voltage.
- Ensure that no metal objects are allowed to fall in the cabinet (risk of electrical arcing).

Failure to observe good engineering practises as well as to follow these safety instructions may expose the user and others to serious injury or death.

**⚠ Risk of damaging the device**

- In case the product is dropped or damaged in any way it is recommended to replace the complete product.

### Accessories

- Bridging bars and connection kits.
- Control voltage transformer (400Vac -> 230Vac).
- DC power supply (12/24Vdc -> 230Vac).
- Mounting spacers to raise the product x 10mm.
- Phase barriers.
- Terminal shrouds / Terminal screens.
- Auxiliary contacts (Additional).
- Padlocking in 3 positions (I - 0 - II).
- Lockout accessories (RONIS - EL 11 AP).
- Door escutcheon frame.
- ATyS D20 Interface (remote control / display unit).
- RJ45 cable for ATyS D20 => ATyS p.
- Voltage sensing kit.
- Current transformers.
- Plug-in optional modules: RS485 MODBUS communication, 2 inputs/2 outputs, Ethernet communication, Ethernet communication + RS485 JBUS/MODBUS gateway, Analogue outputs, Pulse outputs.

For further details refer to the product instruction manual under chapter "Spares and Accessories"



www.socomec.com

To download, brochures, catalogues and technical manuals:  
<http://www.socomec.com/en/documentation-atys-p>

Printing informations: 1 color Black. White paper 90g/m<sup>2</sup>.  
Printing size: 420x297. Final size 210x297. This page visible first.  
CORPORATE HQ CONTACT:  
SOCOMECSAS, 1-4 RUE DE WESTHOUSE, 67235 BENFELD, FRANCE



542 000 F - 10/16 - EN



Non contractual document.  
Subject to change without notice.

## Installation and Commissioning

**STEP 1**  
Cabinet / Back Plate Installation

**STEP 2**  
Power Terminal Connections

**STEP 3**  
COMMAND / CONTROL terminal connections

**STEP 4**  
Power SUPPLY and ATS Controller Terminal Connections

**STEP 5**  
CHECK

**STEP 6**  
PROGRAMMING  
A - Software  
B - Keypad

**STEP 7A**  
AUT Mode  
(Automatic Control)

**STEP 7B**  
AUT Mode  
(Remote Control)

**STEP 7C**  
Manual Mode

**STEP 7D**  
Padlocking Mode

### STEP 4

#### Power Supply, Sensing and Control wiring (ATS Controller)

Connect the product with a cable of section of 1,5 to 2,5 mm<sup>2</sup>.  
Screw M3 - Tightening torque: min.: 0.5 Nm - max.: 0.6 Nm

**ATS Power Supply Input II**  
Power supply II - L/N  
Power supply II - N/L  
208-277 VAC ±20%:  
50/60 Hz

**ATS Voltage Sensing Input Source supply II**  
S II - Phase / Neutral  
S II - Phase  
S II - Phase  
575 VAC (ph-ph) max  
S II - Neutral / Phase  
332 VAC (ph-n) max

**Programmable Inputs**  
To opt. Module/Common  
Progr. Inputs (208-209)  
To opt. Module positive

**Genset Start/Stop Signal**  
NC  
Common  
NO

Current Transformer incoming cable connections

Slots for optional modules  
See on the back "Optional modules"

**ATS Power Supply Input I**  
Power supply I - L/N  
Power supply I - N/L  
208-277 VAC ±20%:  
50/60 Hz

**ATS Voltage Sensing Input Source supply I**  
S I - Phase / Neutral  
S I - Phase  
S I - Phase  
575 VAC (ph-ph) max  
S I - Neutral / Phase  
332 VAC (ph-n) max

**ATS Module Control Inputs (Programmable)**

**ATS Module Output Contact (Programmable)**

**Remote interface RJ45** - to ATyS D20

Recommended to use SOCOMEC Voltage Sensing Kit (refer to ATyS p accessories for details)



# STEP 1

## Installation

Caution: Ensure that the product is installed on a flat rigid surface.

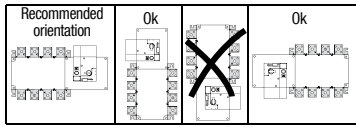

Door cut-out for front panel.

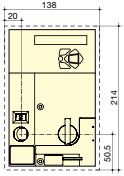

ATyS p 800 to 1000 A

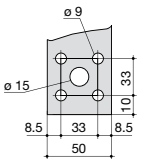

ATyS p 1250 A

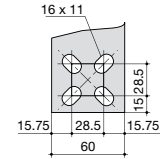

ATyS p 1600 to 3200 A

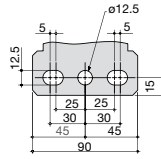

ATyS p 800 to 1600 A

Dimensions in mm.

ATyS p 2000 to 3200 A

	800 A		1000 A		1250 A		1600 A		2000 A		2500 A		3200 A	
	3 P	4 P	3 P	4 P	3 P	4 P	3 P	4 P	3 P	4 P	3 P	4 P	3 P	4 P
<b>M</b>	255	335	255	335	255	335	347	467	347	467	347	467	347	467
<b>T</b>	80	80	80	80	80	80	120	120	120	120	120	120	120	120
<b>C</b>	391	391	391	391	391	391	391	391	523	523	523	523	523	523

# STEP 2

## Power Terminal Connections

To be connected using terminal lugs, rigid or flexible busbars.

	FRAME B6			FRAME B7	FRAME B8		
	800 A	1000 A	1250 A	1600 A	2000 A	2500 A	3200 A
Minimum cable section Cu (mm <sup>2</sup> ) at lth (IEC 60947-1)	2x185	-	-	-	-	-	-
Recommended cable section Cu (mm <sup>2</sup> ) at lth	2x50x5	2x60x5	2x60x7	2x100x5	3x100x5	4x100x5	3x100x10
Maximum cable section Cu (mm <sup>2</sup> )	2x300	4x185	4x185	6x185	-	-	-
Maximum Cu busbar width (mm)	63	63	63	100	100	100	100
Type of screw	M8	M8	M10	M12	M12	M12	M12
Recommended tightening torque (N.m)	8.3	8.3	20	40	40	40	40
Maximum tightening torque (N.m)	13	13	26	45	45	45	45

Example: Control wiring for a 400VAC application having a 3 phase and neutral supply.

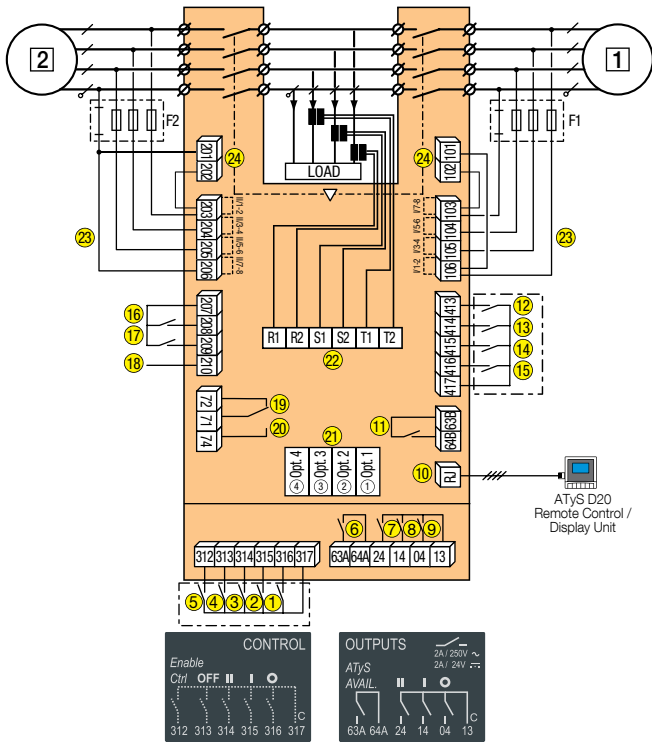

# STEP 3

## CONTROL / COMMAND Terminals

Ensure that the product is in Manual Mode.

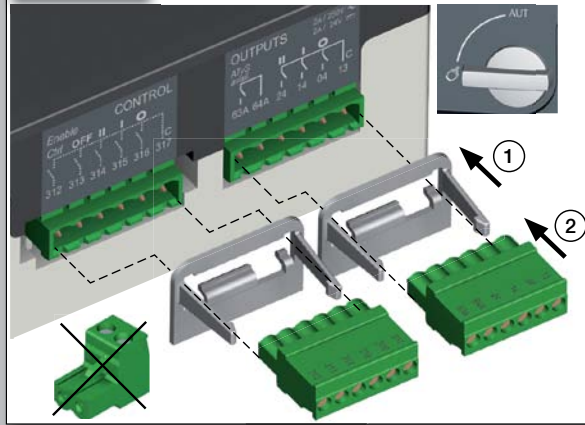

- 1 preferred source 2 alternate source
- 16-17. Programmable Inputs 5-6
- 18. Aux. Supply (207/210) to be used with ATyS optional I/O modules
- 19. Contact "Start/Stop Genset" : if S1 is not available the NC contact le contact (71-72) is close
- 20. Contact "Start/Stop Genset" : if S1 is not available the NO contact le contact (71-74) is open
- 21. Option Module Slots 1 to 4
- 22. Current Transformer incoming cable connections
- 23. Voltage Sensing Inputs
- 24. Power Supply Inputs

## 4.2. Quick Start ATyS p Frame B6 to B8 (800 A to 3200 A) continued

### STEP 5

#### Check

Whilst in manual mode, check the wiring and if ok power up the product.

LED "Power" Green: ON  
LED Manual/Fault Red: ON

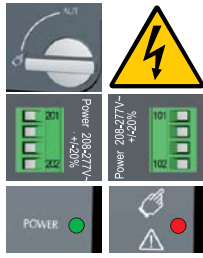

#### Optional Modules

Communication between the software and the ATyS p may be done through the Ethernet/Modbus TCP or Modbus RTU modules that are available as an option. The ETHERNET / MODBUS modules are to be installed in one of the slots provided in the ATyS p ATS control unit.

Easy Config may be used with a PC connected or through ETHERNET or MODBUS modules as well as isolated from the product and simply saved on a PC for download at any convenient time.

**Note:** The ATyS p may accept a total of 4 additional Input / Output modules offering an additional 8 programmable inputs and 8 programmable outputs. When including a MODBUS module the ATyS p accepts a total of 3 I/O modules and when including the ETHERNET module a total of 2 I/O modules.

Refer to the ATyS p accessory section for details.

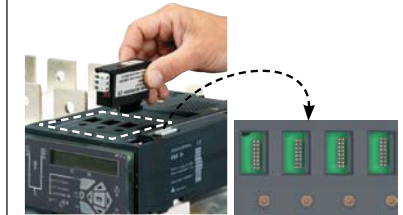

The Ethernet module includes a built in Web Server for Monitoring, Engine Exerciser Control, Events...

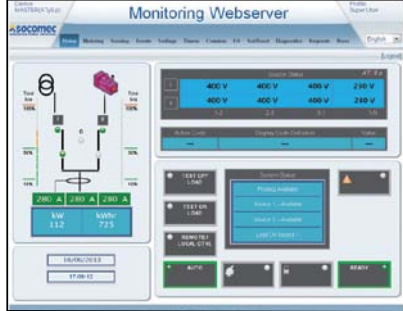

### STEP 6

#### Programming the ATyS p

The ATyS p is to be programmed powered up and after wiring verification tests. This may either be done through the front of the ATS Controller using the keypad or with the user-friendly Easy Config software.

For convenience, we recommend to use the Easy Config software. (Downloadable free from [www.socomec.com](http://www.socomec.com)).

The ATyS p is delivered with default setting values based on most used customer application requirements. The minimum configuration parameters that must be programmed are the type of network and application together with the voltage and frequency nominal values. ATyS p Auto Configuration makes the setup of Volts, Hz, Phase rotation and Neutral Position quick and easy.

#### A - Programming with Easy Config Software

To program the ATyS p using Easy Config software simply follow the setting boxes from left to right until all desired settings in each window have been completed. Help pop ups are included to show the minimum and maximum setting values allowed. The software includes most SOCOMEC products so before programming click NEW and select the product "ATyS p" from the list of products available.

When the ATyS p is powered and communicating, the software will include a screen to monitor and display the ATyS p status.

Control through software (such as changing switch position I-0-II) is also possible when in Super User Mode.



#### B - Programming with the ATyS p keypad

1 SETUP	2 VOLT. LEVELS	3 FREQ. LEVELS	4 PWR. LEVELS	5 TIMERS VALUE	6 I-O	7 COMM	8 DATE/TIME
NETWORK 4NBL	OV. U I 115%	OV. F I 105%	OV.P I 0000 KVA	1FT 0003 SEC	IN 1 --- NO	DHCP NO (9)	YEAR
AUTOCONF NO (7)	OV. U HYS I 110%	OV. F HYS I 103%	OV.P HYS I 0000 KVA	1RT 0180 SEC	IN 2 --- NO	IP 1-2 192.168.	MONTH
NEUTRAL AUTO	UND. U I 085%	UND. F I 095%	OV.P II 0000 KVA	2FT 0003 SEC	IN 3 --- NO	IP 3-4 .002.001 (9)	DAY
ROT PH. ---	UND. U HYS I 095%	UND. F HYS I 097%	OV.P HYS II 0000 KVA	2RT 0005 SEC (2)	IN 4 --- NO	GAT1-2 000.000.	HOUR
NOM. VOLT 400 V	UNB. U I 00%	OV. F II 105%	(1) When «APP» is set to «M-G»	2AT 0005 SEC (1)	IN 5 --- NO	GAT3-4 .000.000 (9)	MINUTE
NOM. FREQ 50 Hz	UNB. U HYS I 00%	OV. F HYS II 103%	(2) When «APP» is set to «M-M»	2CT 0180 SEC (1)	IN 6 --- NO	MSK1-2 255.255.	SECOND
APP M-G	OV. U II 115%	UND. F II 095%	(3) When one of the IP is set to «EON»	2ST 0030 SEC (1)	IN 7 --- NO (8)	MSK3-4 .255.000 (9)	
PRIO TON NO (1)	OV. U HYS II 110%	UND. F HYS II 097%	(4) When one of the O/P is set to «EOP»	ODT 0003 SEC	IN 8 --- NO (8)	ADDRESS 005	
PRIO EON NO (3)	UND. U II 085%		(5) When one of the O/P is set to «EES»	TOT UNL (1)	IN 9 --- NO (8)	BDRATE 9600	
PRIO NET 1 (2)	UND. U HYS II 095%		(6) When the product is in manual mode	TOT 0010 SEC (1)	IN10 --- NO (8)	STOP BIT 1	
RETRANS NO	UNB. U II 00%		(7) If the product is in manual mode	T3T 0000 SEC (1)	IN11 --- NO (8)	PARITY NONE	
CT PRI 100	UNB. U HYS II 00%		(8) With optional I/O modules	TFT UNL (1)	IN12 --- NO (8)		
CT SEC 5			(9) With Ethernet module	TFT 0600 SEC (1)	IN13 --- NO (8)		
S1=SW2 NO				E1T 0005 SEC (3)	IN14 --- NO (8)		
BACKLGHNT INT				E2T UNL (3)	OUT 1 POP NO		
CODE P 1000				E2T 0010 SEC (3)	OUT 2 --- NO (8)		
CODE E 0000				E3T 0005 SEC (3)	OUT 3 --- NO (8)		
BACKUP SAVE				E5T 0005 SEC (4)	OUT 4 --- NO (8)		
				E6T LIM (4)	OUT 5 --- NO (8)		
				E6T 0600 SEC (4)	OUT 6 --- NO (8)		
				E7T 0005 SEC (4)	OUT 7 --- NO (8)		
				LST 0004 SEC (5)	OUT 8 --- NO (8)		
				EET 0168 H (6)	OUT 9 --- NO (8)		
				EDT 1800 SEC (6)			



ATyS p devices may also be programmed through the ATS controller keypad. This programming method is necessary for products not equipped with Ethernet or Modbus communication modules that facilitate programming through Easy Config software described above. The keypad is a useful interface and programming method most especially when changing a few parameters or simply interrogating the product.

**Programming access:** Press and hold for 5 s "Validation" push button (17). Access through the keypad is possible in Automatic or Manual mode, when the product is in a stable position (I, 0 or II) with at least one supply source available. Programming is not accessible whilst any cycle sequence is running.

**To change the configuration:** Enter code (factory code = 1000) using navigation push buttons (14).

**Programming exit:** Press and hold for 5 s "Validation" push button (17).

**Note 1:** Values as listed above are the setting values by default.

**Note 2:** Ensure that the Default Network Setting and Application match the installation or change accordingly before using Auto Configuration.

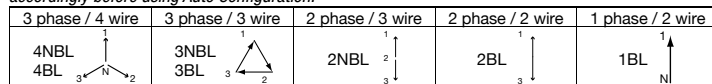

#### Setup by Auto Configuration

(Volts, Hz, Neutral pos., Ph rotation)

Press 5s	[Key]
Go To	1 SETUP
Scroll to	AUTOCONF
Enter code	1000
Set to	YES
Press 60 ms	[Key]
LEDs flash	[LEDs]
Save : press 5s	[Key]

**Note:** Source I or source II must be available to set by Auto Configuration.

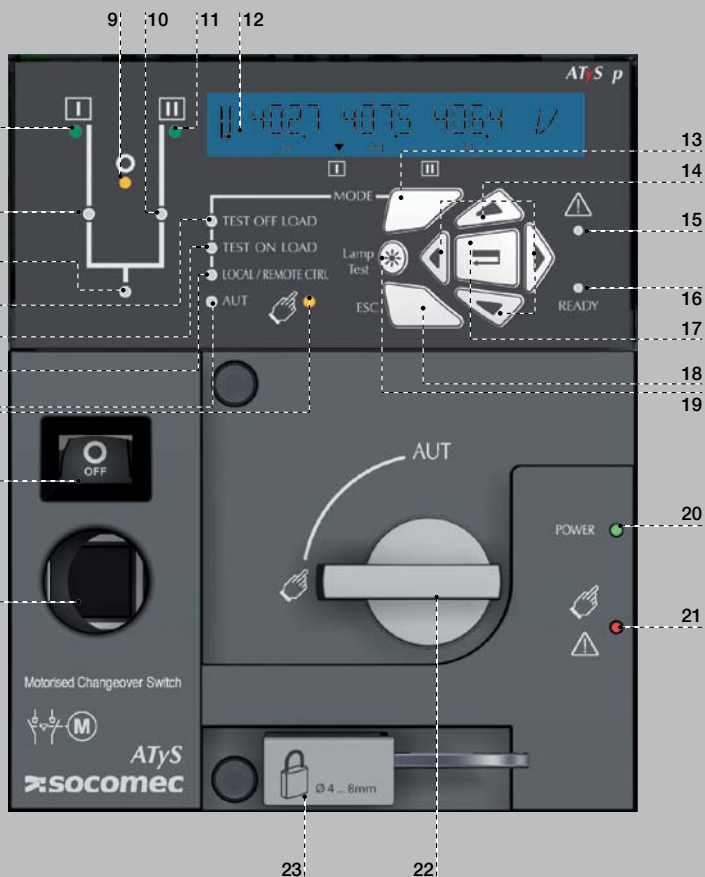

1. MANUAL Mode LED indication. (Yellow steady light when in Manual Mode).
2. AUTO Mode LED indication Green steady light when in Auto mode with no timers running. Green flashing light when in Auto with timers running.
3. LOCAL / REMOTE CONTROL Mode LED indication. Yellow steady light when in Local / Remote control mode. Remote control mode is achieved with the Auto/Manu selector switched to Auto and terminals 312 closed with terminal 317. Remote control orders are received through closing 314 to 316 with 317. REMOTE Control is also achievable through Easy Config ATyS p software when connected to the product through Ethernet or MODBUS. (Optional modules). Local Control selectable and operable through the ATyS p keypad.
4. TEST ON LOAD CONTROL Mode LED indication. (Yellow steady light when in TON/ EON mode)
5. TEST OFF LOAD CONTROL Mode LED indication. (Yellow steady light when in TOF/ EOF mode).
6. Load Supply On LED. (Green when the load is supplied).
7. Switch 1 LED position indication. (Green when in position 1).
8. Source supply I availability LED indication. (Green when supply I voltage is within the set limits).
9. Zero position LED indication. (Yellow when in position 0).
10. Switch 2 LED position indication. (Green when in position 2).
11. Source supply II availability LED indication. (Green when supply II voltage is within the set limits).
12. LCD Display Screen : (Status, measurement, timers, counters, events, faults, programming ....)
13. MODE key to shift between operation modes.
14. Navigation Keys to browse through the ATyS p menus without software.
15. FAULT LED indication. (Red steady light in case of an ATS controller internal fault. Switch the product from Auto to Manual and back to Auto to reset a fault condition).
16. READY LED indication. (Green steady light : Product is powered and in AUTO, Watchdog OK, The Product is Available to changeover).
17. Enter Key used to enter Prog Mode (Press and hold for 5 seconds) and to validate the settings programmed through the keypad.
18. ESC key used to escape from a specific screen up to the main menu.
19. Lamp test key to check the LED's and LCD screen.
20. Green LED Indication: Power
21. Red LED Indication: Product Unavailable / Manual Mode / Fault Condition
22. Auto / Manual mode selector switch (Key version available as an option)
23. Padlocking facility (Up to 3 padlocks of dia. 4 - 8mm)
24. Emergency manual operation shaft location (Accessible only in manual mode)
25. Switch position indication window: I (On switch I) O (Off) II (On switch II).

### STEP 7A

#### AUT Mode (Automatic Control)

Ensure that the emergency handle is not inserted in the product and turn the mode selector to the AUT position. LED "Power" Green: ON  
LED Manual/Default: OFF

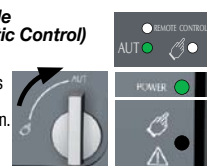

### STEP 7B

#### AUT Mode (Remote Control)

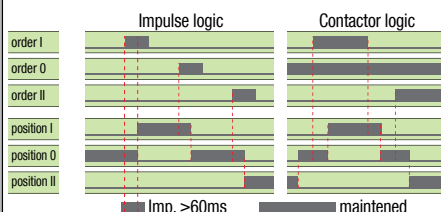

To enable control, close contact 312 with 317. For contactor logic bridge contact 316 with 317. To operate: close the contact corresponding to the desired position. To force the product to 0 position "OFF" bridge contact 313 with 317.



### STEP 7C

#### Manual Mode

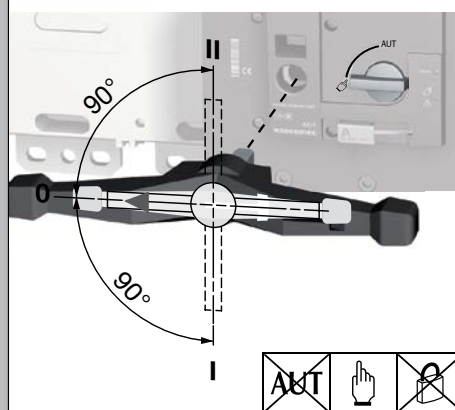

### STEP 7D

#### Padlocking Mode (as standard: in position 0)



# 5. GENERAL OVERVIEW

## 5.1. Product introduction

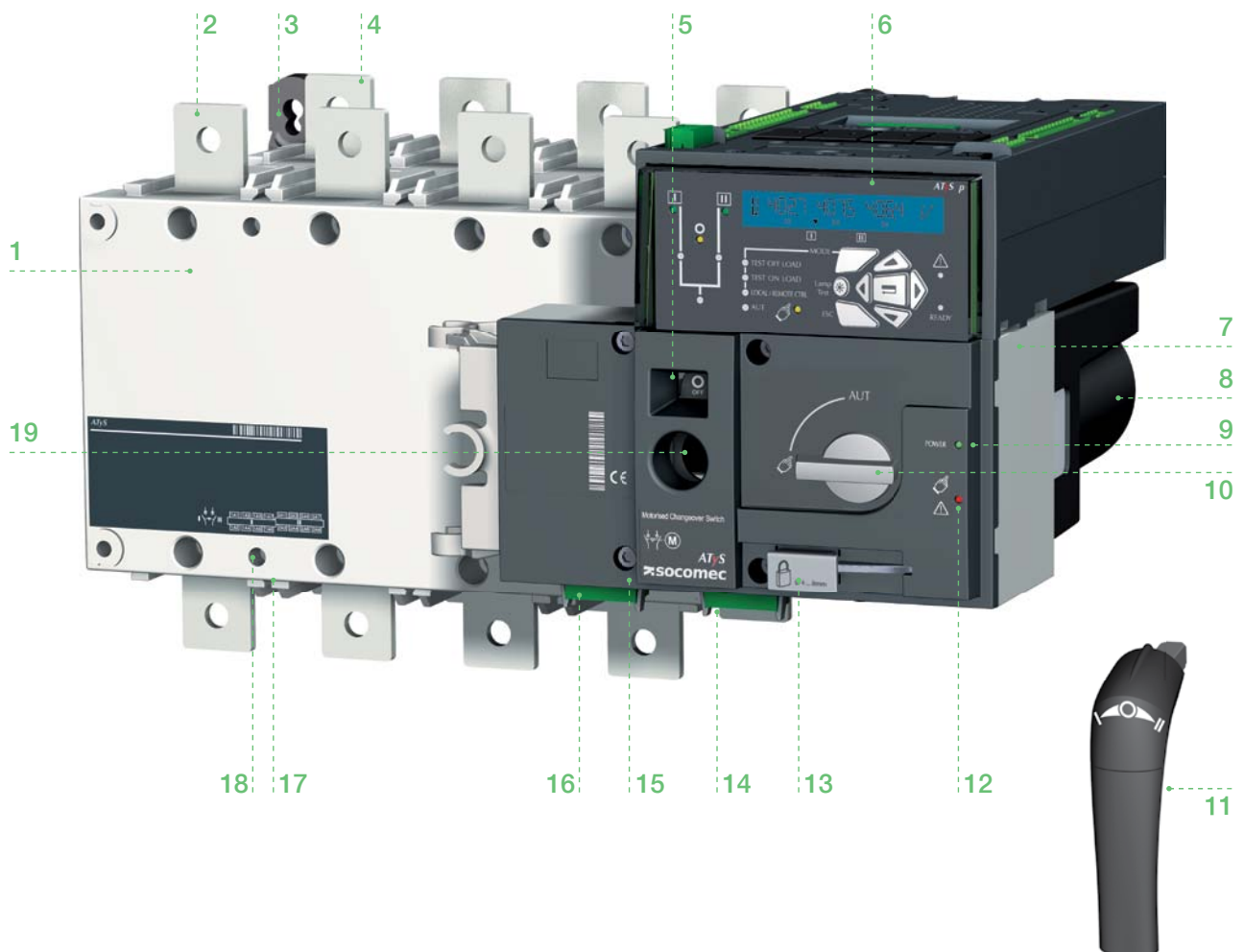

1. Power Section: Changeover switch assembly with inherent mechanical interlock
2. Front: Switch number 1 terminals (3 or 4 pole)
3. Back-plate mounting ATyS fixing lugs
4. Back: Switch number 2 terminals (3 or 4 pole)
5. Switch position indication window: I (On) – O (Off) – II (On)
6. ATS control module with integrated dual power supply
7. Motorized Control Unit
8. Motor housing
9. Green LED Indication: Power
10. Auto / Manual mode selector switch
11. Emergency manual operation “Direct Handle”
12. Red LED Indication: Product Unavailable / Manual Mode / Fault Condition
13. Padlocking facility (Up to 3 padlocks of dia. 4 – 8 mm)
14. Output contacts x 4 (Position indication I-O-II and product availability outputs)
15. Facility for locking all controls in the zero position using a RONIS EL11AP Lock
16. Input contacts x 5:  
 Position order I-O-II  
 Remote control enable  
 Override controls and force to Off position
17. Sliders for Terminal Shields
18. Fixing holes for terminal Shields
19. Emergency manual operation shaft location (Accessible only in manual mode)

## 5.2. Product identification

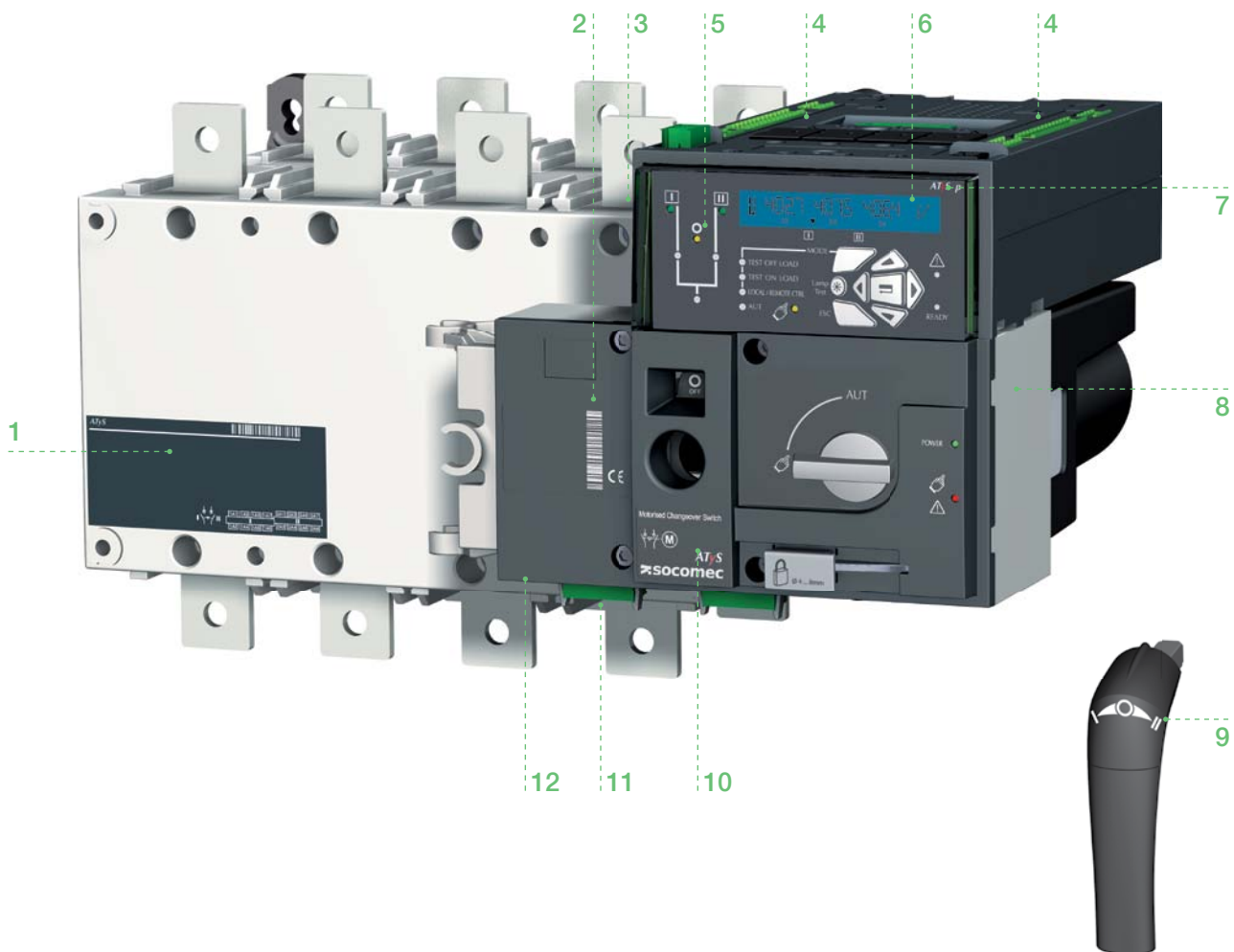

1. Main changeover switch identification label:  
Electrical characteristics  
Applicable standards and  
Terminal incoming and outgoing wiring details.
2. Product serial number, barcode & CE marking.
3. Switch 1 (Front) and Switch 2 (back) identification labels
4. ATS controller terminal contact identification labels
5. Network status and switch position pictogram with LED's
6. ATyS p LCD Screen .
7. ATyS product type identification. (ATyS t, ATyS g or ATyS p)
8. Motor barcode and serial number
9. Emergency manual operation direction of rotation indication
10. ATyS p product current rating and reference number label
11. Output contacts identification label
12. Input contacts identification label

### 5.3. ATs Control module interface

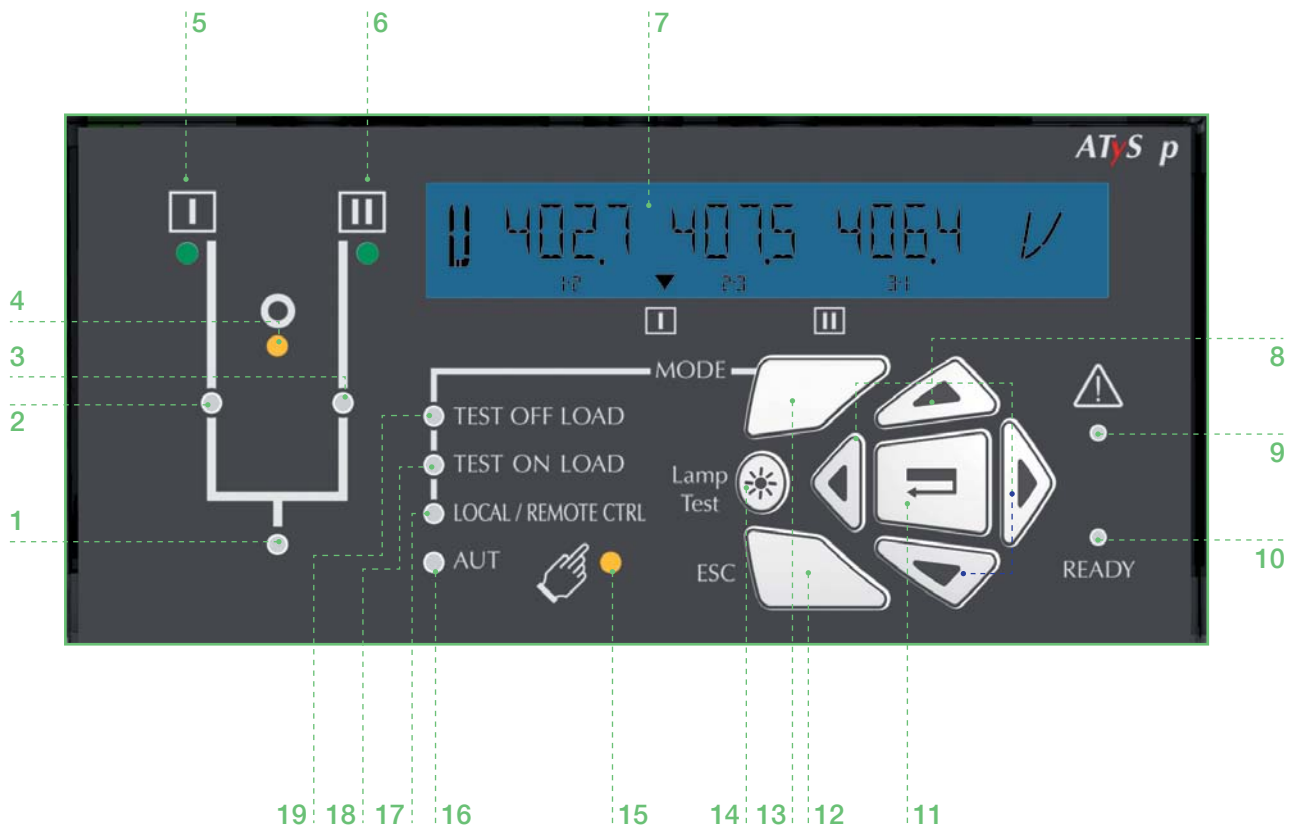

1. Load Supply On LED (Steady green when the load is normally supplied and flashing green when the load is supplied with load shedding output LSC active).
2. Switch 1 LED position indication. (Green when in position I).
3. Switch 2 LED position indication. (Green when in position II).
4. Zero position LED indication. (Yellow when in position 0).
5. Source supply I availability LED indication. (Green when supply I voltage is within the set limits).
6. Source supply II availability LED indication. (Green when supply II voltage is within the set limits).
7. LCD Display Screen: (Status, measurement, timers, counters, events, faults, programming...)
8. ATyS p Keypad for direct access to the product configuration, programming and parameters. (Navigation Keys to browse through the ATyS p menus without software).
9. FAULT LED indication. (Red steady light in case of an ATS controller internal fault.  
Switch the product from Auto to Manual and back to Auto to reset a fault condition).
10. READY LED indication. (Green steady light: Product is powered and in AUTO, Watchdog OK.  
The Product is Available to changeover).
11. Enter Key used to enter Prog Mode (Press and hold for 5 seconds) and to validate the settings programmed through the keypad.
12. ESC key used to escape from a specific screen up to the main menu.
13. MODE key to shift between operation modes.
14. Lamp test key to check the LED's and LCD screen.
15. MANUAL Mode LED indication. (Yellow steady light when in Manual Mode).
16. AUTO Mode LED indication  
Green steady light when in Auto mode with no timers running.  
Green flashing light when in Auto with timers running.
17. LOCAL / REMOTE CONTROL Mode LED indication.  
Yellow steady light when in Local / Remote control mode.  
Local Control selectable and operable through the ATyS p keypad.  
Remote control mode is achieved with the Auto/Manu selector switched to Auto and terminals 312 closed with terminal 317. Remote control orders are received through closing 314 to 316 with 317.  
REMOTE Control is also achievable through EasyConfig ATyS p software when connected to the product through Ethernet or MODBUS. (Optional modules)
18. TEST ON LOAD CONTROL Mode LED indication. (Yellow steady light when in TON mode).
19. TEST OFF LOAD CONTROL Mode LED indication. (Yellow steady light when in TOF mode).

## 5.4. Environmental

The ATyS p product meets the following environmental requirements:

### 5.4.1. IP Rating



- IP2X against direct contact for the ATyS p motorization control unit.
- IP2X against direct contact for the power section with the connections in place and when including suitable, correctly installed incoming and outgoing terminal shields.
- IP 0 for the bare power section without terminal shields in place.

### 5.4.2. Operating Conditions

#### 5.4.2.1. Temperature



- From -20 to +40 °C without derating
- From -20 to +70 °C when applying a Kt derating correction factor

Kt: Correction Factor	Temperature
0.9	40 °C ... 50 °C
0.8	50 °C ... 60 °C
0.7	60 °C ... 70 °C

\* Simplified derating method:  $I_{thu} \leq I_{th} \times K_f$

\* A more precise calculation may be done for specific applications. Should this be required please contact SOCOMEC.

#### 5.4.2.2. Hygrometry



- 80% humidity without condensation at 55 °C
- 95% humidity without condensation at 40 °C

#### 5.4.2.3. Altitude



- Up to 2000m in altitude without derating
- For higher altitude the Ka correction factors below apply

Ka: Correction Factor	2000 m < A ≤ 3000 m	3000 m < A ≤ 4000 m
Ue	0.95	0.8
Ie	0.85	0.85

### 5.4.3. Storage Conditions



#### 5.4.3.1. Temperature

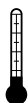

- From -40 to +70 °C

### 5.4.3.2. Storage duration period

- Maximum storage up to a period of 12 months
- (Recommendation: To be stored in dry, non corrosive and non saline atmospheric conditions)

### 5.4.3.3. Storage position

- ≤ 630 A: a maximum of 3 boxes may be stocked vertically
- ≥ 800 A: a maximum of 1 box may be stocked vertically

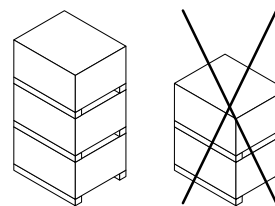

### 5.4.4. Volume and shipping weights by reference ATyS p

Frame Size	Rating	N° of Poles	Reference Number	Weight (kg)		Volume (cm) inc Packing
				Net	Gross	
B3	125 A	3	95 73 <b>3 012</b>	6,8	10,1	360x480x370
		4	95 73 <b>4 012</b>	8,0	11,3	360x480x370
	160 A	3	95 73 <b>3 016</b>	6,8	10,1	360x480x370
		4	95 73 <b>4 016</b>	8,0	11,3	360x480x370
	200 A	3	95 73 <b>3 020</b>	6,8	10,1	360x480x370
		4	95 73 <b>4 020</b>	8,0	11,3	360x480x370
B4	250 A	3	95 73 <b>3 025</b>	7,7	11,0	360x480x370
		4	95 73 <b>4 025</b>	8,5	11,8	360x480x370
	315 A	3	95 73 <b>3 031</b>	7,8	11,1	360x480x370
		4	95 73 <b>4 031</b>	8,9	12,2	360x480x370
	400 A	3	95 73 <b>3 040</b>	7,8	11,1	360x480x370
		4	95 73 <b>4 040</b>	8,9	12,2	360x480x370
B5	500 A	3	95 73 <b>3 050</b>	12,5	15,8	536x378x427
		4	95 73 <b>4 050</b>	14,4	17,7	536x378x427
	630 A	3	95 73 <b>3 063</b>	13,0	16,3	536x378x427
		4	95 73 <b>4 063</b>	15,1	18,4	536x378x427
B6	800 A	3	95 73 <b>3 080</b>	29,0	45,0	730x800x600
		4	95 73 <b>4 080</b>	33,3	49,3	730x800x600
	1000 A	3	95 73 <b>3 100</b>	29,5	45,5	730x800x600
		4	95 73 <b>4 100</b>	34,0	50,0	730x800x600
	1250 A	3	95 73 <b>3 120</b>	30,0	46,0	730x800x600
		4	95 73 <b>4 120</b>	34,7	50,7	730x800x600
B7	1600 A	3	95 73 <b>3 160</b>	34,2	50,2	730x800x600
		4	95 73 <b>4 160</b>	40,5	56,5	730x800x600
B8	2000 A	3	95 73 <b>3 200</b>	51,8	67,8	730x800x600
		4	95 73 <b>4 200</b>	62,7	78,7	730x800x600
	2500 A	3	95 73 <b>3 250</b>	51,8	67,8	730x800x600
		4	95 73 <b>4 250</b>	62,7	78,7	730x800x600
	3200 A	3	95 73 <b>3 320</b>	62,1	78,1	730x800x600
		4	95 73 <b>4 320</b>	76,4	92,4	730x800x600



### 5.4.5. CE marking

The ATyS p complies with the European directive for:

- The Electromagnetic compatibility no. 2004/108/CE dated 15th of December 2004.
- Low voltage directive no. 2006/95/CE dated 12th of December 2006.



### 5.4.6. Lead free process

- The ATyS p complies with the European directive for RoHS.



### 5.4.7. WEEE

The ATyS p is built in accordance with 2002/96/CE directive:

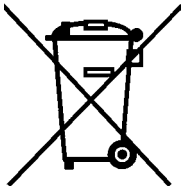

### 5.4.8. EMC standard

The ATyS p is designed and built in accordance with IEC 60947-1 standards (Products intended to be installed in an «Industrial, Commercial and/or Residential Environment» therefore respecting both Class A as well as Class B EMC requirements).

Description	Std (IEC)	Requirement (criteria)
Conducted	CISPR 11	Class B
Radiated	CISPR 11	Class B
ESD contact	61000-4-2	4KV (B)
ESD air	61000-4-2	8KV (B)
Electromagnetic field	61000-4-3	10V/m (A)
RF Conducted	61000-4-6	10V (A)
Burst	61000-4-4	2KV (A) power 1KV (A) control
Surge differential	61000-4-5	1KV (A)

## 5.5. ATyS p ACCESSORIES AVAILABLE

### BRIDGING BARS

To connect switch I & II load terminals together.

### VOLTAGE SENSING AND POWER SUPPLY KIT

Allows voltage sensing and power supply connections from switch terminals to power supply and control module. Secure cables tray, no specific cable protection required (fuse type).

### TERMINAL SHROUDS (125 TO 630 A)

Incoming and outgoing protection against direct contact with the connection terminals or parts. Cannot be mounted in the rear position at the same time as the voltage sensing and power outlet kit or the bridging bars.

Can be mounted top or bottom, in front or in rear position.

### TERMINAL SCREENS

Incoming and outgoing protection against direct contact with the connection terminals or parts.

### REMOTE INTERFACES D20

- Remote Display: Allows source supply state and switch positions to be displayed remotely.
- Remote Control: Allows remote configuration, control and metering (from front panel) on which the device is mounted.

Typically door mounted or  $\leq 3\text{m}$  away from the ATyS.

### DOOR ESCUTCHEON PLATE

An accessory to be fixed onto a cabinet door to frame the controller part of flush mounted ATyS p transfer switches.

### CURRENT TRANSFORMERS

An extensive range of CT's is available from SOCOMEC. Refer to the SOCOMEC general catalogue for details.

### COMMUNICATION CABLE

RJ 45 communication cable (3m long) for use with the D20 remote display/controller or Ethernet modules.

### DC POWER SUPPLY (DC -> AC)

Allows a standard 230 VAC ATyS p to be supplied through a 12/24/48 VDC Aux Power supply.

### SUPPLEMENTARY AUXILIARY CONTACT (AC)

Pre-breaking and signaling of positions I and II: 1 additional auxiliary contact NO / NC auxiliary contact in each position. Included as standard for ratings from 2000 to 3200 A. For Low level AC: please consult SOCOMEC.

### KEY LOCK AUTO / MANUAL SELECTOR SWITCH

The ATyS p mode selector switch is delivered with a rotary handle as standard. This can be replaced with a key lock.

### RONIS KEY PADLOCKING ACCESSORIES

Locking of the electrical and manual operation by means of a RONIS EL11AP lock. Possibility of locking in all positions, if the "Padlocking in the 3 positions" option is ordered.

Not compatible with flush mounting.

### PADLOCKING IN 3 POSITIONS

Allows locking of the operation in the 3 positions I, 0 and II. (Factory fitted accessory)

### CONTROL VOLTAGE TRANSFORMER

Allows a standard 230 V AC device to be supplied with 400 VAC.

### MOUNTING SPACERS (125 TO 630 A)

Raises the device's terminals 10 mm away from the backplate or frame

### OPTIONAL MODULES

#### **Communication modules (3 Types)**

Configuration, Monitoring and control of the changeover switch via Ethernet / Ethernet Gateway (RJ45 connection) or MODBUS, (2 or 3-wire RS485 link).

Besides communication, the Ethernet module includes Webserver monitoring integrated in the module. This gives remote user friendly access (through internet) to ATyS p setting parameters, history of events, metering, engine exerciser settings without the need for additional software. Configuration of the ATyS p is recommended to be done using the SOCOMEC Easy Config software used with a standard laptop/computer having an RJ45 connection (to use with the Ethernet module) or a USB connection (used with a USB/RS485 converter) for MODBUS modules.

#### **Input / Output Extension Module**

2 Inputs/2 Outputs on each module with a maximum of 4 modules on each ATyS p. (Attn: When used with an Ethernet module the remaining space available is for 2 I/O modules. Similarly when used with a Modbus module the remaining space available is for 3 I/O modules.

#### **4-20mA analogue output module**

3I, In, 3V, 3U, F,  $\pm \Sigma P$ ,  $\pm \Sigma Q$ ,  $\Sigma S$

(Attn: To be configured through a communication module)

#### **Pulsed output module**

2 configurable pulse outputs (type, weight and duration) on  $\pm \text{kWh}$ ,  $\pm \text{kvarh}$  and  $\text{kVAh}$

(Attn: To be configured through a communication module)

#### **Others:**

Refer to the end of this instruction manual or the latest SOCOMEC product catalogue.

(Downloadable from [www.socomec.com](http://www.socomec.com))

# 6. INSTALLATION

## 6.1. Product dimensions

### 6.1.1. Dimensions: Frame B3 to B5 (125 A to 630 A)

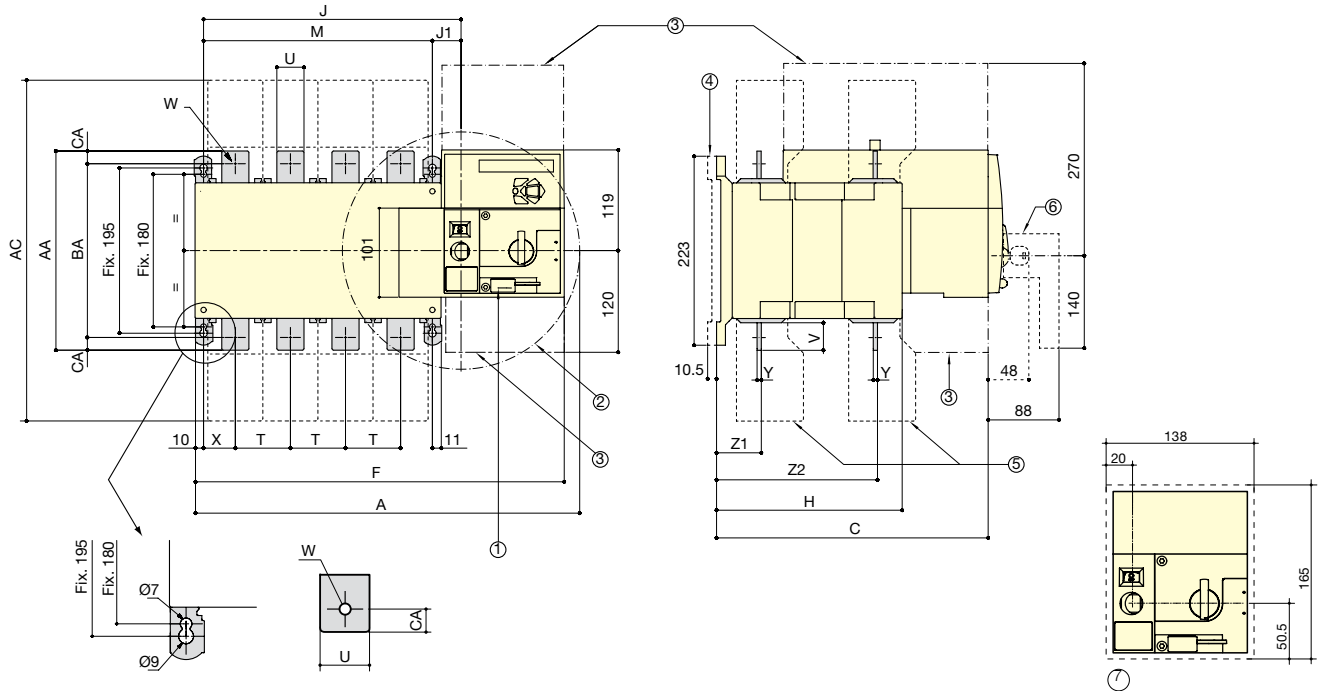

1. Padlocking Facility: Locking bracket for up to 3 padlocks of dia. 4 – 8 mm
2. Emergency manual operation: Maximum operating radius with an operating angle of 2x 90°
3. Connection and disconnection area
4. Mounting stand off with spacer accessory
5. Phase Barriers
6. Emergency removable handle
7. Flush mounting cutout dimensions for front door

CAUTION

To consider the space required for manual operation and wiring.  
(When using the ATyS p emergency handle: note 2).

Rating (A)	Overall dimensions			Terminal shrouds	Body							Switch mounting		Connection										
	A 3p.	A 4p.	C		AC	F 3p.	F 4p.	H	J 3p.	J 4p.	J1	M 3p.	M 4p.	T	U	V	W	X 3p.	X 4p.	Y	Z1	Z1	AA	BA
125	304	334	244	233	286.5	317	151	154	184	34	120	150	36	20	25	9	28	22	3.5	38	134	135	115	10
160	304	334	244	233	286.5	317	151	154	184	34	120	150	36	20	25	9	28	22	3.5	38	134	135	115	10
200	304	334	244	233	286.5	317	151	154	184	34	120	150	36	20	25	9	28	22	3.5	38	134	135	115	10
250	345	395	244	288	328	378	152	195	245	35	160	210	50	25	30	11	33	33	3.5	39.5	133.5	160	130	15
315	345	395	244	288	328	378	152	195	245	35	160	210	50	25	30	11	33	33	3.5	39.5	133.5	160	130	15
400	345	395	244	288	328	378	152	195	245	35	160	210	50	35	35	11	33	33	3.5	39.5	133.5	170	140	15
500	394	454	321	402	377	437	221	244	304	34	210	270	65	45	50	13	42.5	37.5	5	53	190	260	220	20
630	394	454	321	402	377	437	221	244	304	34	210	270	65	45	50	13	42.5	37.5	5	53	190	260	220	20

All dimensions in mm

## 6.1.2. Dimensions: Frame B6 & B7 (800 A to 1600 A)

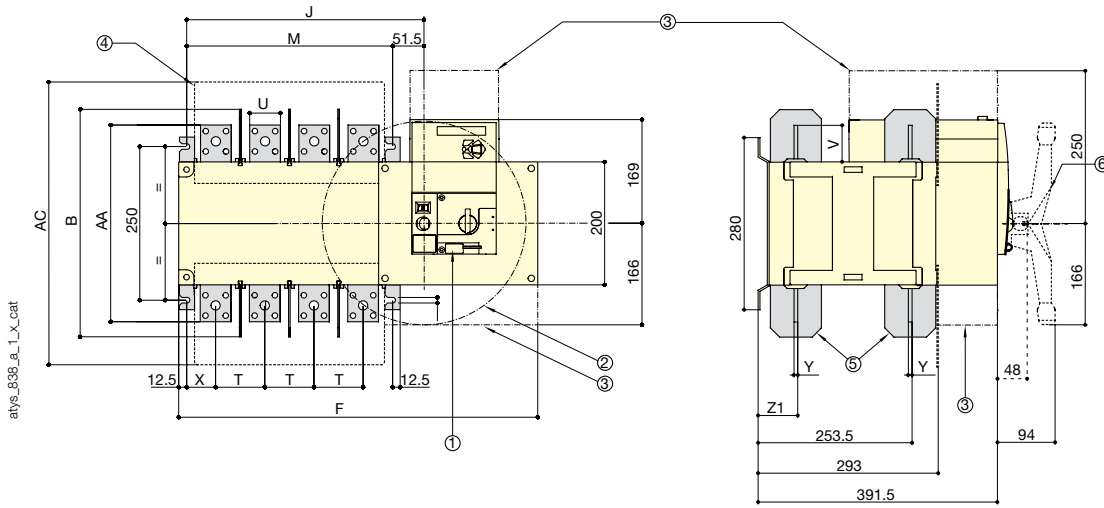

800 to 1000 A

1250 A

1600 A

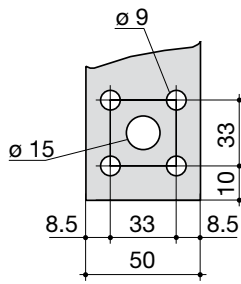

svr\_077\_a\_1\_x\_cat

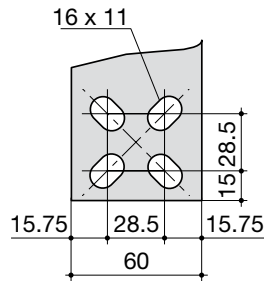

svr\_078\_b\_1\_x\_cat

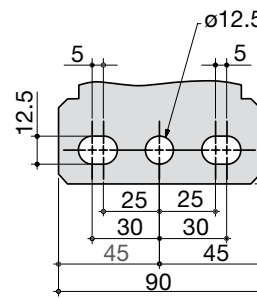

svr\_088\_a\_1\_x\_cat

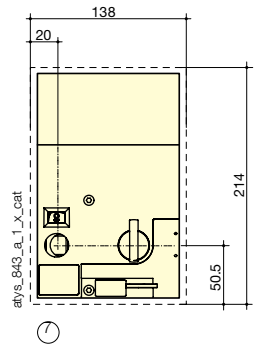

1. Padlocking Facility: Locking bracket for up to 3 padlocks of dia. 4 – 8 mm
2. Emergency manual operation: Maximum operating radius with an operating angle of 2x 90°
3. Connection and disconnection area
4. Mounting stand off with spacer accessory
5. Phase Barriers
6. Emergency removable handle
7. Flush mounting cutout dimensions for front door



**CAUTION**

To consider the space required for manual operation and wiring.  
(When using the ATyS p emergency handle: note 2).

Rating (A)	Overall dimensions		Terminal screens		Body				Switch mounting		Connection					
	B	AC	F 3p.	F 4p.	J 3p.	J 4p.	M 3p.	M 4p.	T	U	V	X	Y	Z1	AA	
800	370	461	504	584	307	387	255	335	80	50	60.5	47.5	7	66.5	321	
1000	370	461	504	584	307	387	255	335	80	50	60.5	47.5	7	66.5	321	
1250	370	461	504	584	307	387	255	335	80	60	65	47.5	7	66.5	330	
1600	380	531	596	716	399	519	347	467	120	90	44	53	8	67.5	288	

All dimensions in mm

### 6.1.3. Dimensions: Frame B8 (2000 A to 3200 A)

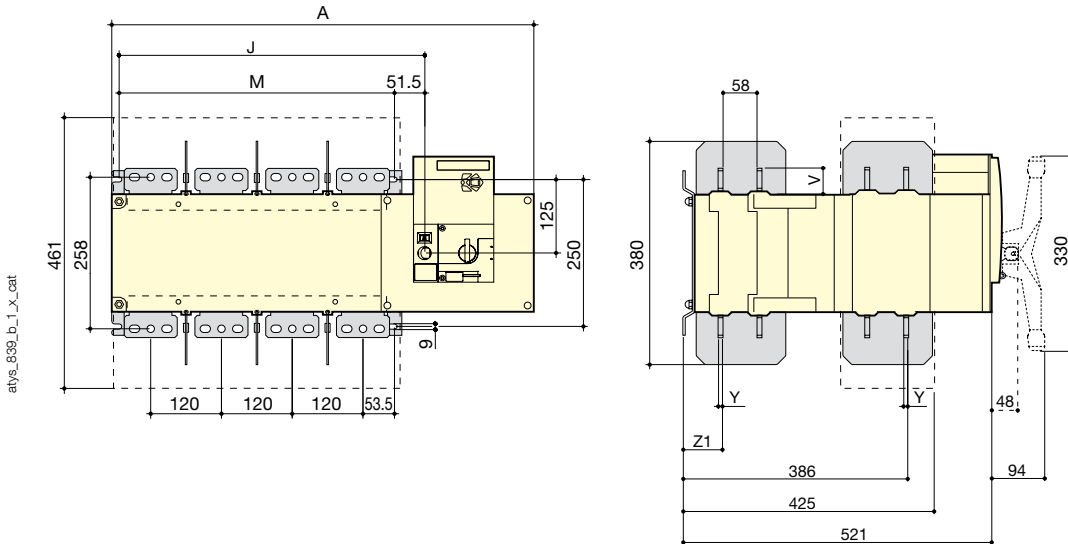

2000 to 3200 A

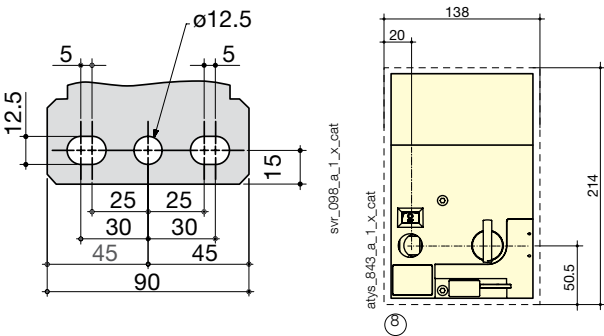

1. Padlocking Facility: Locking bracket for up to 3 padlocks of dia. 4 – 8 mm
2. Emergency manual operation: Maximum operating radius with an operating angle of 2x 90°
3. Connection and disconnection area
4. Mounting stand off with spacer accessory
5. Phase Barriers
6. Emergency removable handle
7. Frame B8, (Dual frame) factory fitted power terminal connections
8. Flush mounting cutout dimensions for front door

CAUTION

To consider the space required for manual operation and wiring.  
(When using the ATyS p emergency handle: note 2).

Rating (A)	Overall dimensions B	Terminal screens AC	Body				Switch mounting		Connection							
			F 3p.	F 4p.	J 3p.	J 4p.	M 3p.	M 4p.	T	U	V	X	Y	Z1	AA	
2000 ... 3200	380	531	347	467	399	519	347	467	120	90	44	53	8	67,5	288	

All dimensions in mm

## 6.2. Mounting orientation

125 A to 630 A	Recommended	OK	Not Allowed	OK
800 A to 3200 A	Recommended	Not Allowed	OK	OK

CAUTION
Always install the product on a flat and rigid surface.

## 6.3. Assembly of customer mounted accessories

<span style="background-color: red; color: white; padding: 2px 10px; font-weight: bold; margin-left: 5px;">DANGER</span>	Never handle any customer mounted accessories while there may be the risk of voltage being or becoming present.
--	---

### 6.3.1. Terminal shrouds

Available from 125 A to 630 A  
Frame B3 to Frame B5:

- Upstream, downstream, front or rear mounting.
- When fitted with bridging bars only the front terminal shrouds are to be installed.

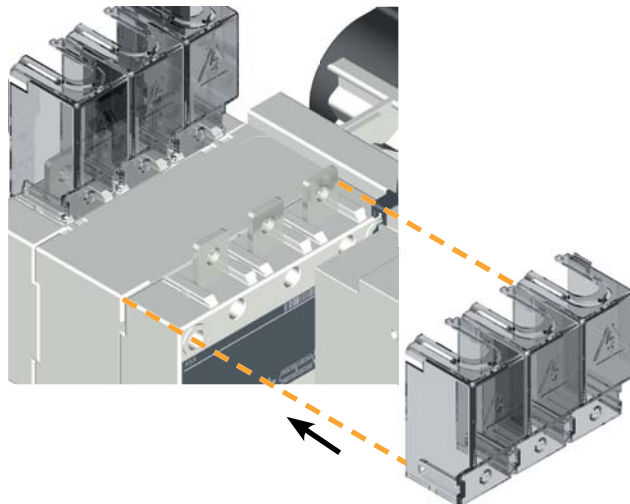

### 6.3.2. Terminal screens

125 A to 630 A

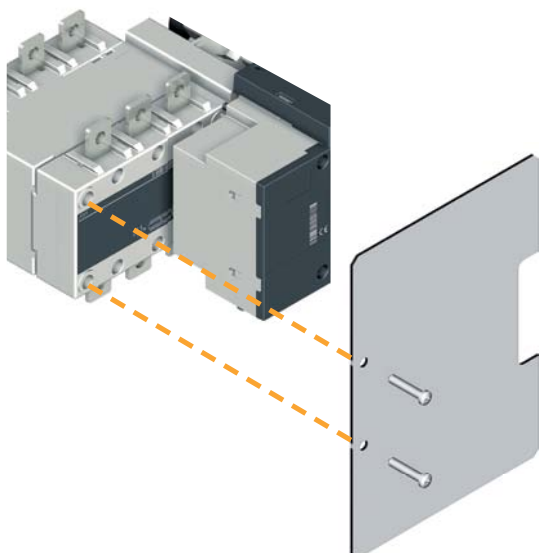

500 A to 1600 A

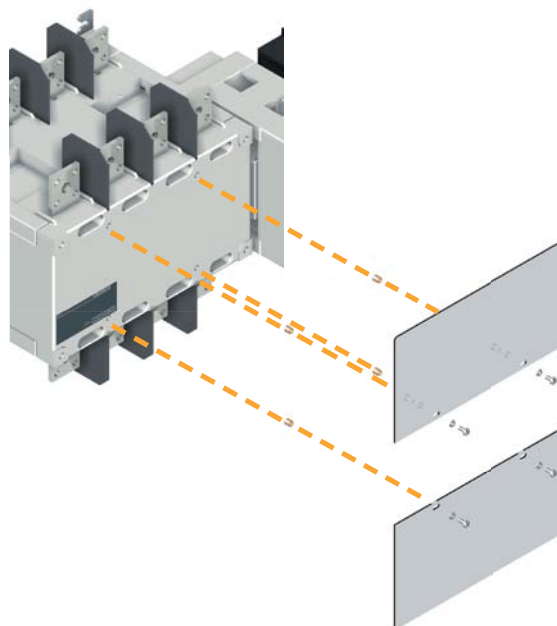

## 2000 A to 3200 A

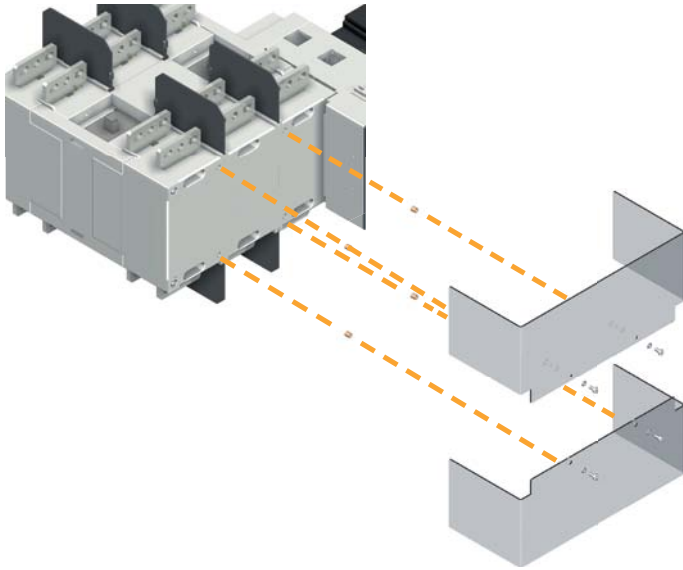

### 6.3.3. Bridging bar installation

#### 125 A to 630 A

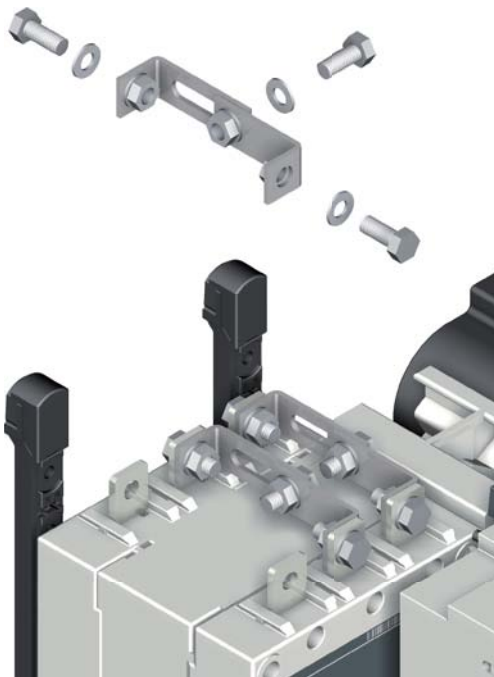

#### 800 A to 1600 A

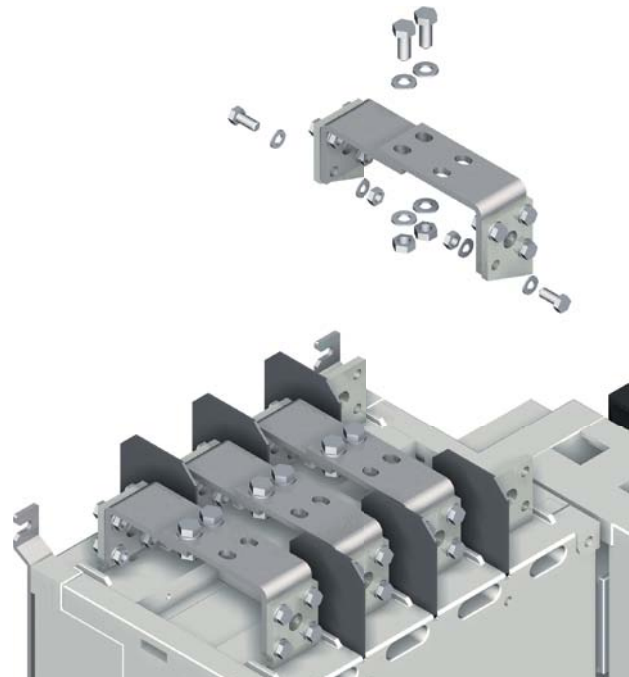

**It is possible to mount the bridging bars on either side of the switch.**

Recommended tightening torque:

M6: 4,5 N.m  
M8: 8,3 N.m  
M10: 20 N.m  
M12: 40 N.m

Maximum tightening torque:

M6: 5,4 N.m  
M8: 13 N.m  
M10: 26 N.m  
M12: 45 N.m

### 6.3.4. Copper bar connection kits (2000A to 3200A : Frame B8)

 Conditions of use of these products may lead to a derating.

 [SOCOME C "Application guide"](#)

 [www.socomec.com](http://www.socomec.com)

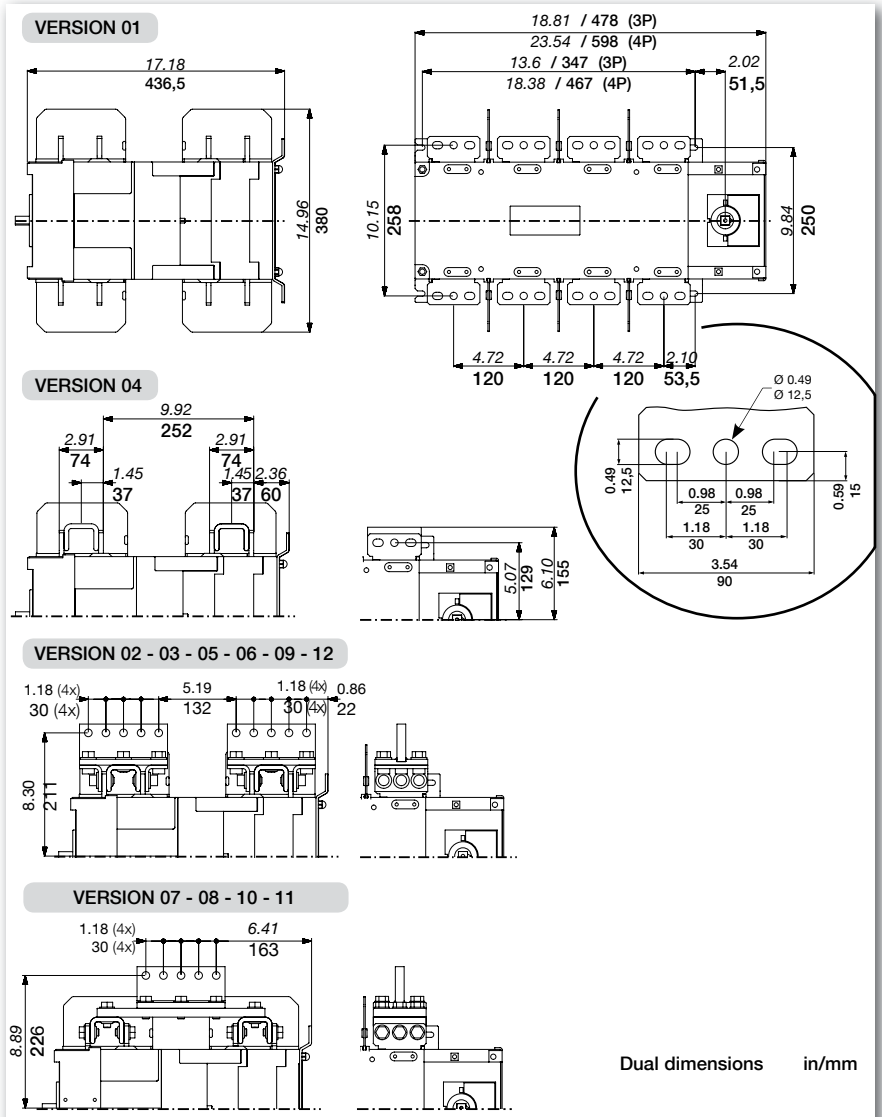
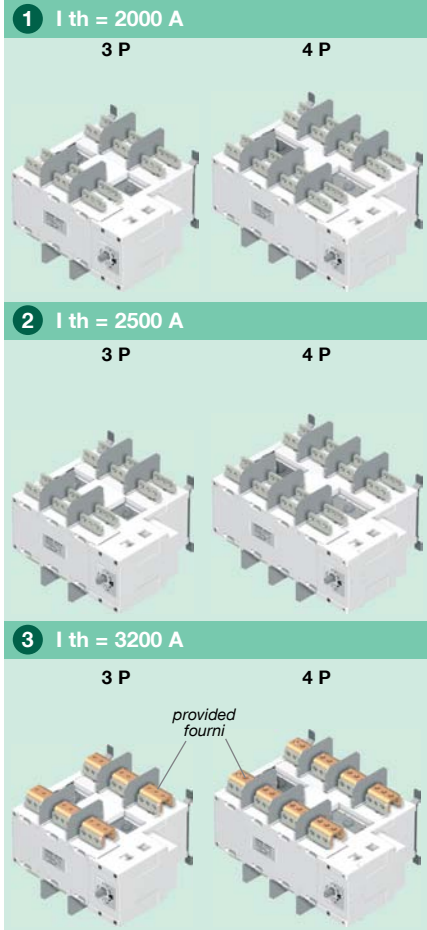











Dual dimensions in/mm

Data for Bolts, Nuts and Washers for Busbar Connections.

 TO BE SUPPLIED BY OTHERS

**Connection reference numbers and contents:**

 x 1 <i>included with 3200A product as standard</i> <b>2619 1200</b>	 x 6 708 lb-in 80 Nm <b>2699 1200</b> <b>2699 1201</b>	 x 1 +  x 6 708 lb-in 80 Nm <b>2629 1200</b>
 x 2 +  x 6 708 lb-in 80 Nm <b>2639 1200</b>	 x 1 +  x 6 708 lb-in 80 Nm <b>4109 0250</b>	 x 1 +  x 6 708 lb-in 80 Nm <b>4109 0320</b>

VERSION	H M12-35 6.8 - 6 x	Rondelle contact MOY. M M12 NFE 25 511	H M12
01	12 x	6 x	6 x
02	6 x	3 x	3 x
03	10 x	5 x	5 x
04	A H M12-35 6.8 - 3 x	3 x	-
	B H M12-45 6.8 - 3 x	3 x	-
05	6 x	3 x	3 x
06	10 x	5 x	5 x
07	6 x	3 x	3 x
08	10 x	5 x	5 x
09	20 x	10 x	10 x
10	6 x	3 x	3 x
11	10 x	5 x	5 x
12	20 x	10 x	10 x

**Note:** Reference numbers and quantity given above and below are for one connection and per pole. For a full set multiply the quantity indicated by the number of poles (3 or 4 pole) and then multiply by 2 (N° of switches)



### 6.3.5. Incoming copper bar connection kit assembly

2000A – 2500A (Minimum Cu bar section for Ith 2000A 3x100x5mm; and for Ith 2500A 4x100x5mm)

VERSION 01

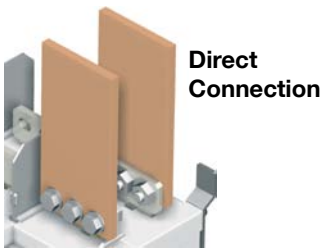

VERSION 02

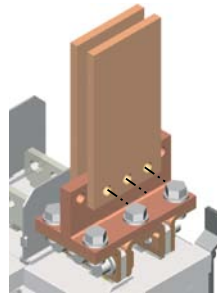

VERSION 03

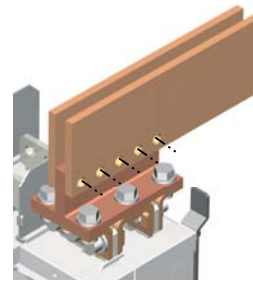

**V2 & V3**

Kit :  
2619 1200 x 1  
2629 1200 x 1  
2639 1200 x 1

3200A (Minimum Cu bar section 3x100x10mm)

VERSION 04

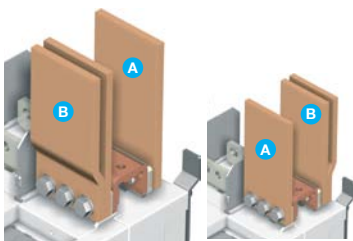

VERSION 05

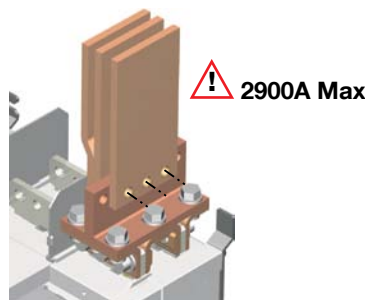

VERSION 06

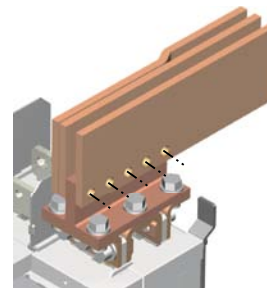

Connection bar 2619 1200 included with 3200A

**V4**

Kit :  
2699 1200 x 1

**V5 & V6**

Kit :  
2629 1200 x 1  
2639 1200 x 1

### 6.3.6. Outgoing bridge connection assembly

2000A – 2500A (Minimum Cu bar section for Ith 2000A 3x100x5mm; for Ith 2500A 4x100x5mm)

VERSION 07

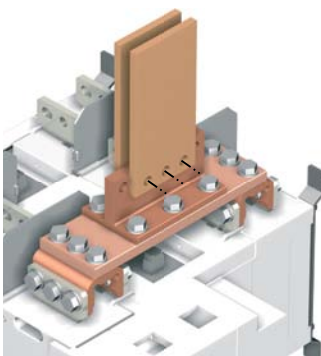

VERSION 08

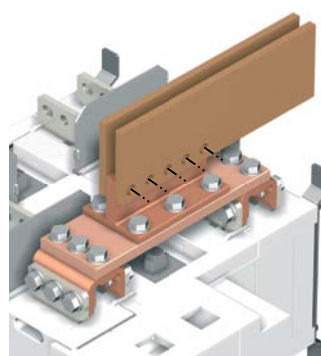

VERSION 09

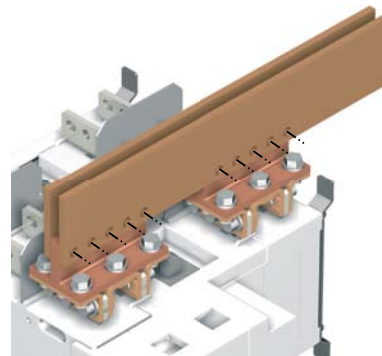

**V7 & V8**

Kit :  
2619 1200 x 2  
2699 1201 x 2  
2629 1200 x 1  
4109 0320 x 1

**V9**

Kit :  
2619 1200 x 2  
2629 1200 x 2  
2639 1200 x 2

3200A (Minimum Cu bar section 3x100x10mm)

VERSION 10

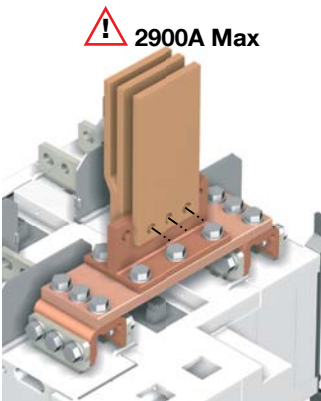

VERSION 11

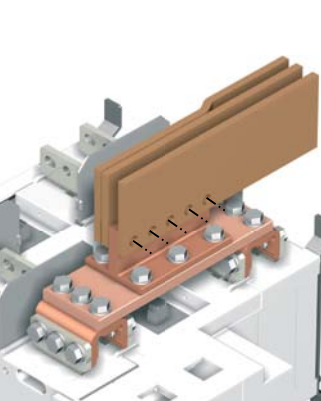

VERSION 12

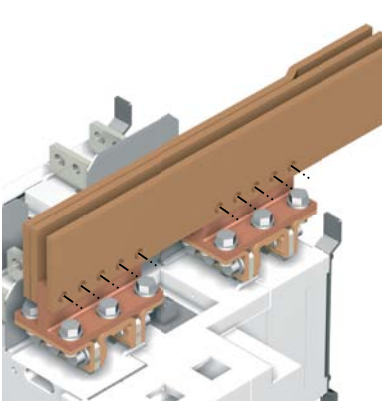

Connection bar 2619 1200 included with 3200A

**V10 & V11**

Kit :  
2699 1201 x 2  
2629 1200 x 1  
4109 0320 x 1

**V12**

Kit :  
2629 1200 x 2  
2639 1200 x 2

### 6.3.7. External Power supply (400 VAC - 230 VAC)

Power Transformer intended for 400 VAC, Phase to Phase voltage applications that do not provide the availability of a neutral conductor. Transformer data: 400 VAC – 230 VAC: 200VA. The ATyS p will require 2 transformers to be connected as shown.

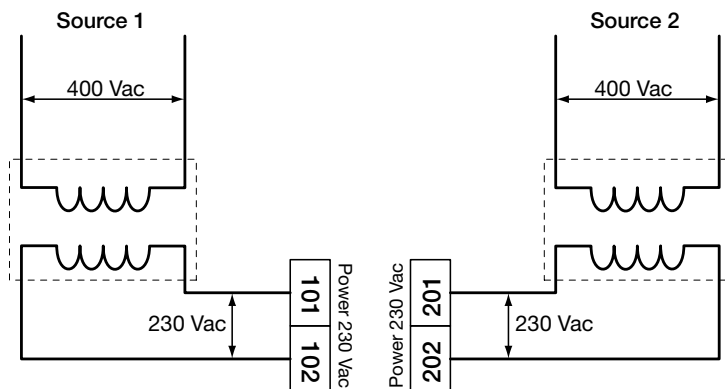

### 6.3.8. Raised mounting spacers

Available for 125 A to 630 A ratings only  
Frames B3, B4 and B5

1 set including 2 spacers raises the device's terminals 10 mm away from the bottom of the enclosure or frame on which the device is mounted. These may also be used to replace the original mounting spacers.



### 6.3.9. Padlocking key interlocks

Intended for locking the electrical control and the backup control in position 0 using a RONIS EL11AP lock. As standard, key locking is in the 0 position. Optionally and when including the option “padlocking in 3 positions” key locking will be in positions I, 0 or II

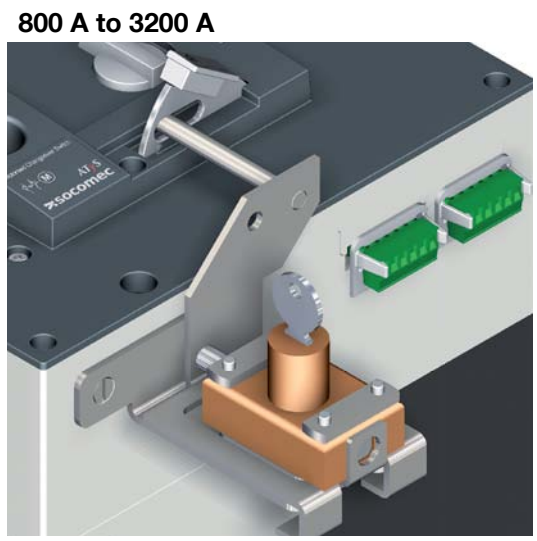
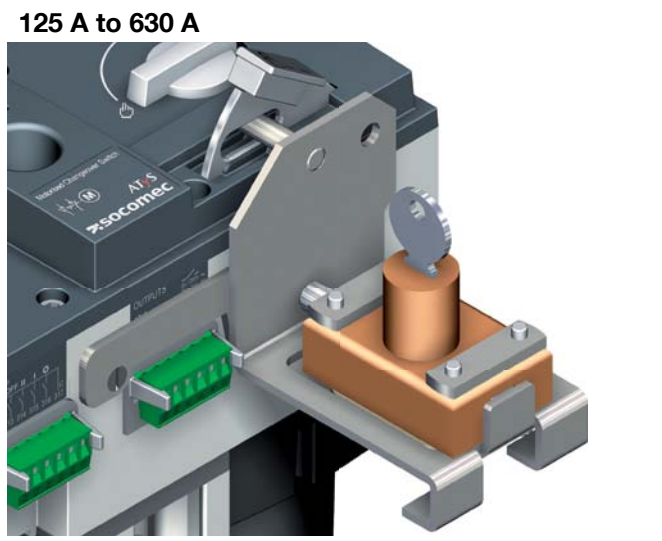

### 6.3.10. Additional auxiliary contacts

Intended for pre breaking and signaling of positions I and II:  
 A maximum of 2 NO/NC additional auxiliary contacts can be fitted for each position. (Customer assembly may be required.)

**125 A to 630 A (Optional)**

**800 A to 1600 A (Optional)  
 2000 A to 3200 A (Standard)**

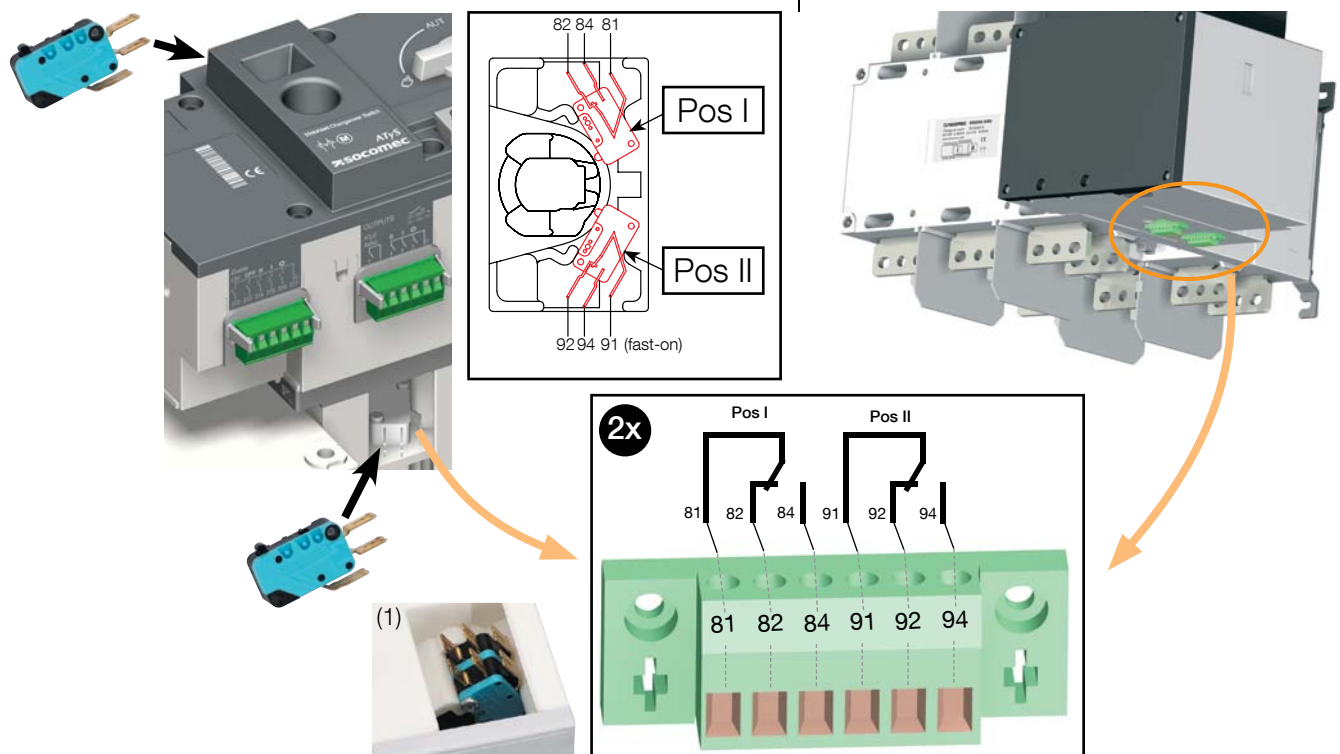

<sup>(1)</sup> When mounting one auxiliary contact on position I or II, use the short screws provided. When mounting two auxiliary contacts on position I or II, use the long screws provided.

## 6.4. ATyS p Optional module installation



### RS485 MODBUS® communication

- RS485 link with MODBUS® protocol (speed up to 38400 bauds).



### Ethernet communication with RS485 MODBUS gateway

- Ethernet link with TCP or MODBUS RTU over TCP.
- Connection of 1 to 247 RS485 MODBUS slaves.
- Embedded Ethernet Webserver software.



### 2 inputs - 2 outputs

- Each module has 2 programmable inputs and 2 programmable outputs available.



### Analogue outputs

- Outputs assignable to:  
3I, In, 3V, 3U, F,  $\pm \Sigma P$ ,  $\pm \Sigma Q$ ,  $\Sigma S$ .



### Ethernet communication

- Ethernet link with MODBUS/TCP or MODBUS RTU over TCP.
- Embedded Ethernet Webserver software.



### Pulse outputs

- 2 configurable pulse outputs (type, weight and duration) on  $\pm$  kWh,  $\pm$  kvarh and kVAh.

The ATyS p includes four slots on the top part of the ATS controller that are dedicated to fixing of optional modules.

The modules are available as an option so as to suit the various user requirements.

Depending on the option mix selected an ATyS may accept a maximum of any 4 single module units or 2 single module + 1 double module. (Double modules are for Ethernet).

The modules may be mounted in any slot (1-4) and configured according to their location.

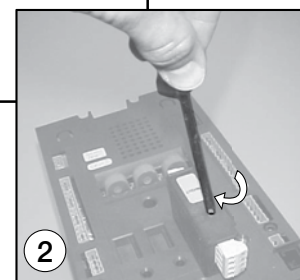
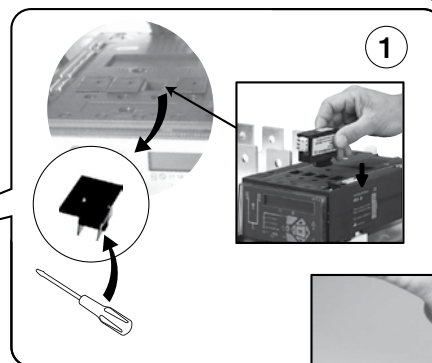
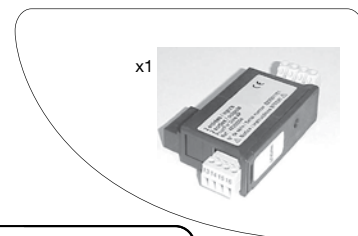
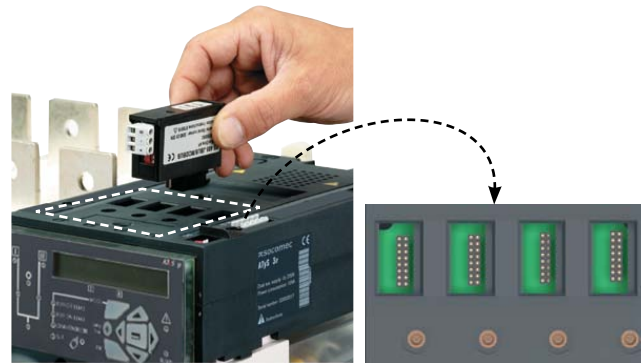

**CAUTION**

Connect the modules with the power off.  
Ensure that the option fixing bolts are tightened correctly.  
A 3 minute power outage is required to recognize an optional module.

# 7. CONNECTIONS

## 7.1. Power circuits

For specific networks and power connection diagram possibilities, please refer to page 39.

### 7.1.1. Cable or bar connections

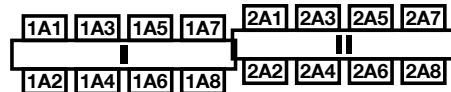
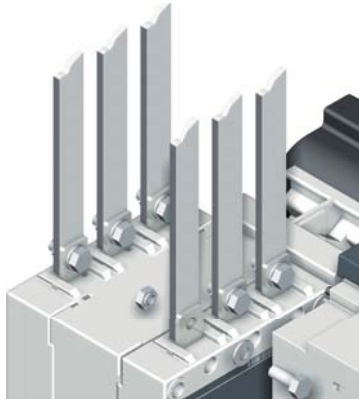

Recommended tightening torque: <ul style="list-style-type: none"> <li>• M6: 4,5 N.m</li> <li>• M8: 8,3 N.m</li> <li>• M10: 20 N.m</li> <li>• M12: 40 N.m</li> </ul>	Maximum tightening torque: <ul style="list-style-type: none"> <li>• M6: 5,4 N.m</li> <li>• M8: 13 N.m</li> <li>• M10: 26 N.m</li> <li>• M12: 45 N.m</li> </ul>
---	--

### 7.1.2. Power connection terminals

**125A to 630A** - Refer to section "Product dimensions", page 27 for power connection terminal details.

#### 800A to 1000A

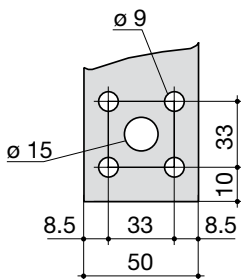

svr\_077\_a\_1\_x\_cat

#### 1250A

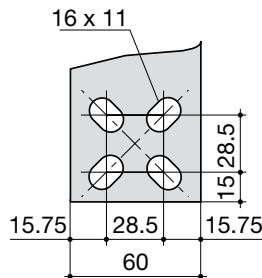

svr\_078\_b\_1\_x\_cat

#### 1600A to 3200A

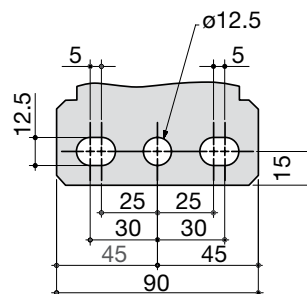

### 7.1.3. Power connection cross-section

	B3			B4			B5		B6			B7	B8		
	125A	160A	200A	250A	315A	400A	500A	630A	800A	1000A	1250A	1600A	2000A	2500A	3200A
Minimum cable section Cu according to IEC 60947-1 (mm <sup>2</sup> )	35	35	50	95	120	185	2x95	2x120	2x185	-	-	-	-	-	-
Recommended cable section Cu (mm <sup>2</sup> ), lth	-	-	-	-	-	-	2x32 x5	2x40 x5	2x50 x5	2x63 x5	2x60 x7	2x100 x5	3x100 x5	2x100 x10	3x100 x10
Maximum cables section Cu (mm <sup>2</sup> )	50	95	120	150	240	240	2x185	2x300	2x300	4x185	4x185	6x185	-	-	-
Maximum bars width Cu (mm)	25	25	25	32	32	32	50	50	63	63	63	100	100	100	100

Note for all ratings: Take into account the connection cable lengths and/or others environmental specific operating conditions.

## 7.1.4. Connection

The product is delivered with the following configuration.

- Connectors 101 to 106, I 1/2 to I 7/8, located on the right side of the controller are associated with switch I
- Connectors 201 to 206, II 1/2 to II 7/8, located on the left side of the controller are associated with switch II.

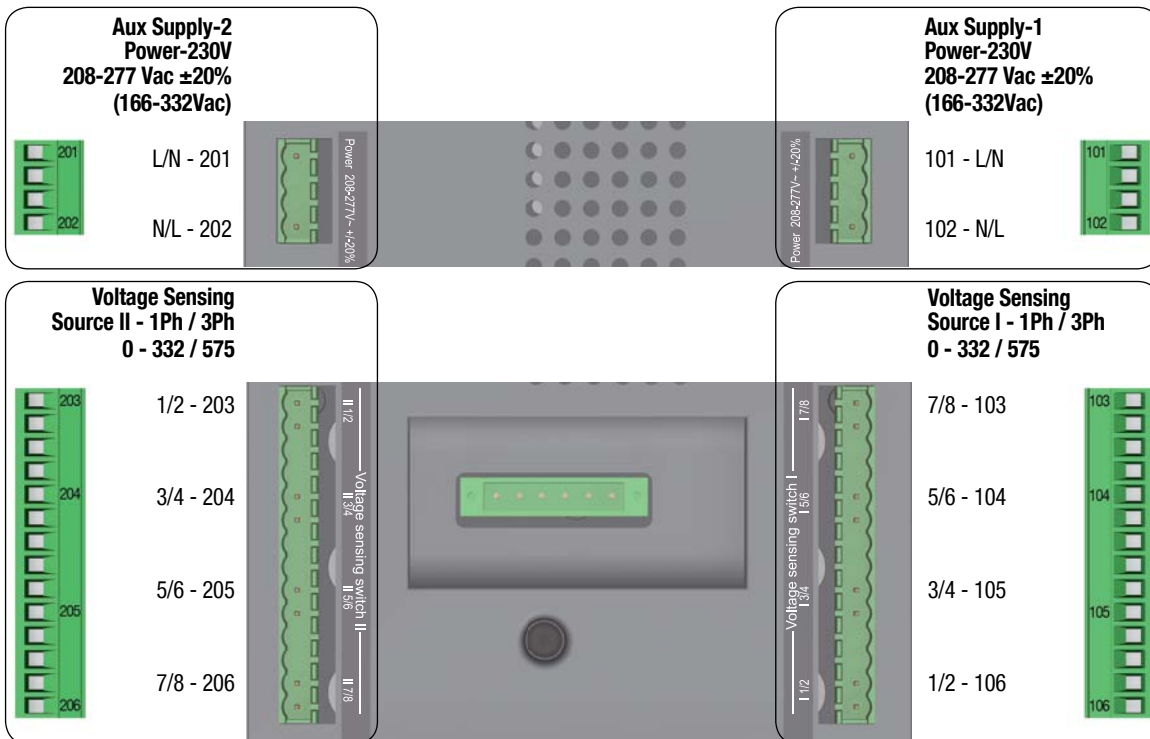
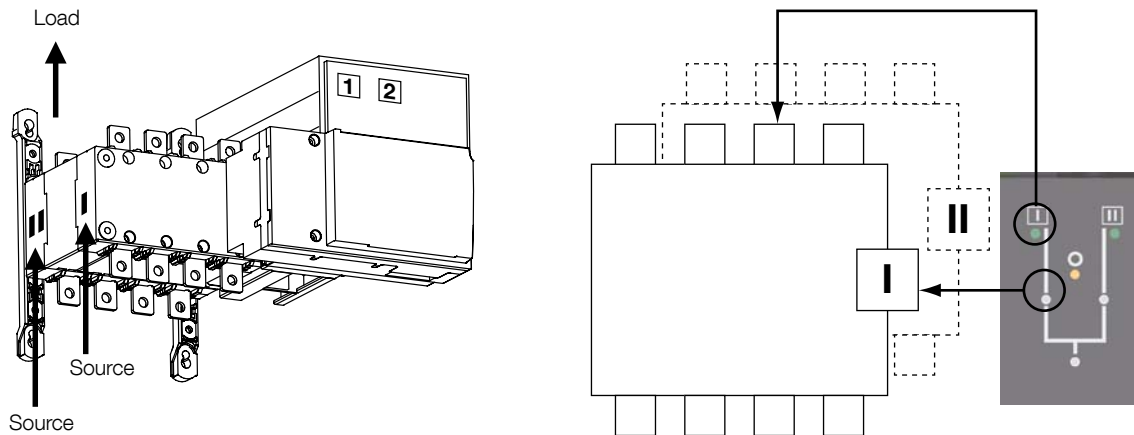

**CAUTION**

It is recommended to connect power and sensing with the ATyS voltage sensing and power supply kit available as an accessory. In this case ensure to mount the kit before connecting the power cables.

## 7.2. Networks and Power Connection possibilities

### 7.2.1. Type of networks

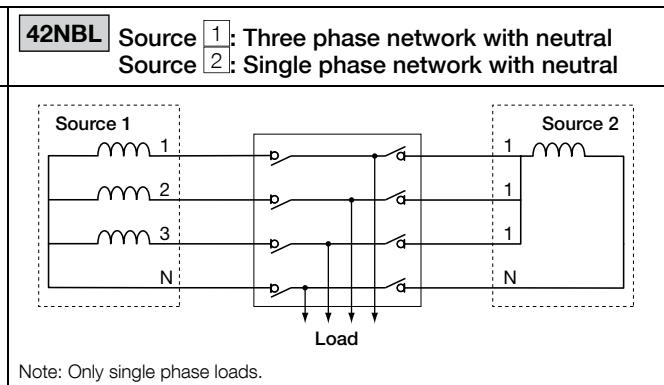
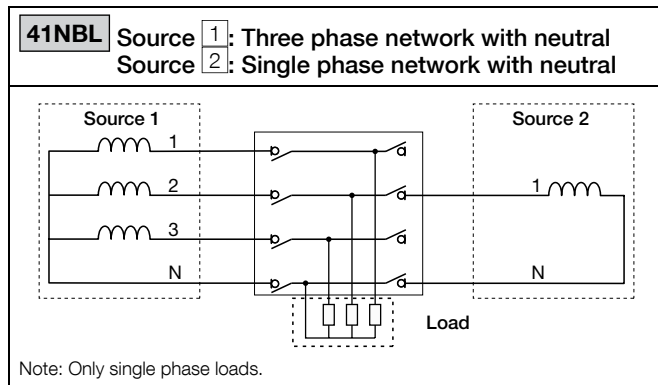
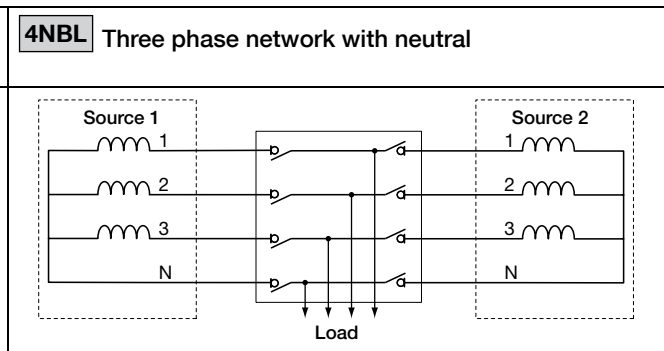
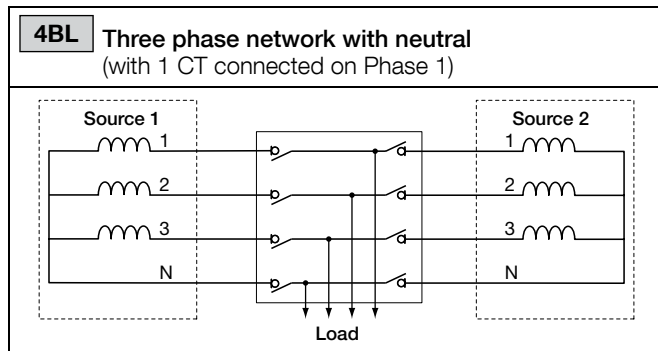
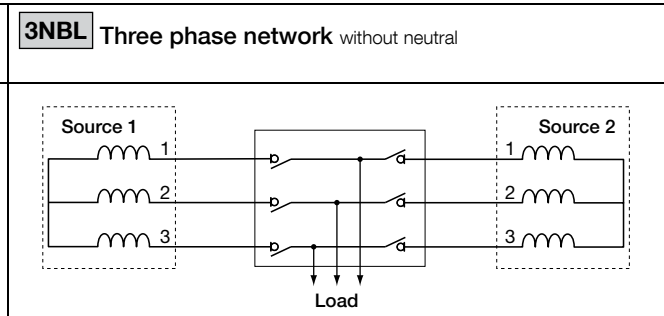
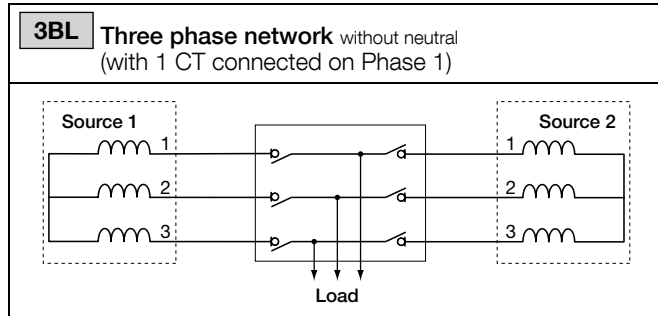
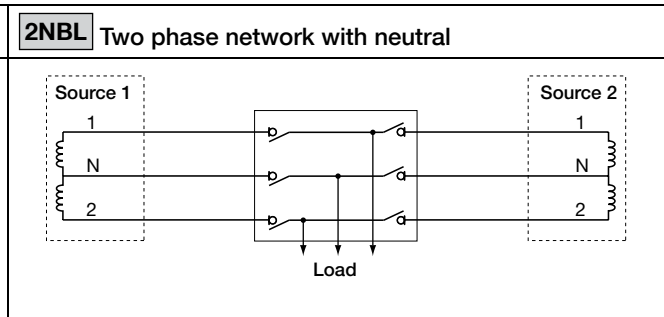
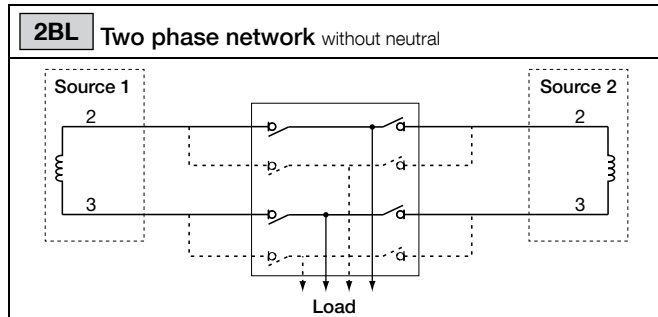
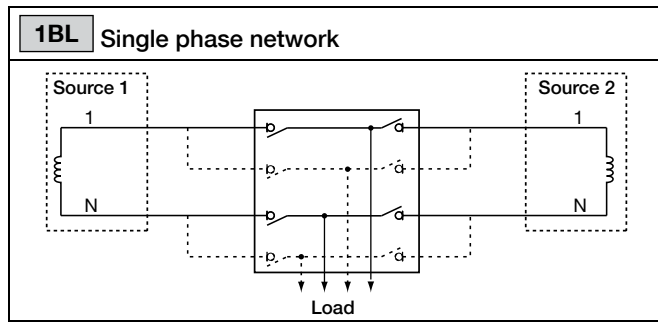

## 7.2.2. Metering and sensing details

Network type									
	1BL	2 BL	2NBL	3BL	3NBL	4BL	4NBL	41NBL	42NBL
Source [1]	1 phase 2 wire	2 phase 2 wire	2 phase 3 wire	3 phase 3 wire	3 phase 3 wire	3 phase 4 wire	3 phase 4 wire	3 phase 4 wire	3 phase 4 wire
Source [2]								1 phase 2 wire	3x1 phase 4 wire
Source [1]									
Source [2]									
ATyS p CT cabling (load side)									
Voltage sensing									
Source [1]	- V1	U23	U12 V1, V2	U12, U23, U31	U12, U23, U31	U12, U23, U31 V1, V2, V3	U12, U23, U31 V1, V2, V3	U12, U23, U31 V1, V2, V3	U12, U23, U31 V1, V2, V3
Source [2]	- V1	U23 -	U12 V1, V2	U12, U23, U31 -	U12, U23, U31 -	U12, U23, U31 V1, V2, V3	U12, U23, U31 V1, V2, V3	- V1	- V1, V2, V3
Source presence (source available)	✓	✓	✓	✓	✓	✓	✓	✓	✓
Source in ranges (U, V, F)	✓	✓	✓	✓	✓	✓	✓	✓	✓
Rotation phase order	-	-	-	✓	✓	✓	✓	S1 only	S1 only
Neutral position	-	-	✓	-	-	✓	✓	S1 only	S1 only
Voltage unbalanced is lower than threshold	-	-	-	✓	✓	✓	✓	S1 only	S1 only
Metering applicable to ATyS p									
Source [1]	- V1 f1	U23 f1	U12 V1, V2 f1	U12, U23, U31 f1	U12, U23, U31 f1	U12, U23, U31 V1, V2, V3 f1	U12, U23, U31 V1, V2, V3 f1	U12, U23, U31 V1, V2, V3 f1	U12, U23, U31 V1 f1
Source [2]	- V1 f2	U23 f2	U12 V1, V2 f2	U12, U23, U31 f2	U12, U23, U31 f2	U12, U23, U31 V1, V2, V3 f2	U12, U23, U31 V1, V2, V3 f2	- V1 f2	- 3xV1 f2
If CT connected (load side)	- - - P <sub>T</sub> , Q <sub>T</sub> , S <sub>T</sub> , PF <sub>T</sub>	- - - P <sub>T</sub> , Q <sub>T</sub> , S <sub>T</sub> , PF <sub>T</sub>	P1, Q1, S1, PF1 P2, Q2, S2, PF2 - P <sub>T</sub> , Q <sub>T</sub> , S <sub>T</sub> , PF <sub>T</sub> I1, I2	- - - P <sub>T</sub> , Q <sub>T</sub> , S <sub>T</sub> , PF <sub>T</sub> I1, I2, I3	P1, Q1, S1, PF1 P2, Q2, S2, PF2 P3, Q3, S3, PF3 P <sub>T</sub> , Q <sub>T</sub> , S <sub>T</sub> , PF <sub>T</sub> I1, I2, I3, I <sub>n</sub>	- - - P <sub>T</sub> , Q <sub>T</sub> , S <sub>T</sub> , PF <sub>T</sub> I1, I2, I3	P1, Q1, S1, PF1 P2, Q2, S2, PF2 P3, Q3, S3, PF3 P <sub>T</sub> , Q <sub>T</sub> , S <sub>T</sub> , PF <sub>T</sub> I1, I2, I3, I <sub>n</sub>	P1, Q1, S1, PF1* P2, Q2, S2, PF2 P3, Q3, S3, PF3 P <sub>T</sub> , Q <sub>T</sub> , S <sub>T</sub> , PF <sub>T</sub> I1, I2, I3, I <sub>n</sub>	P1, Q1, S1, PF1* P2, Q2, S2, PF2 P3, Q3, S3, PF3 P <sub>T</sub> , Q <sub>T</sub> , S <sub>T</sub> , PF <sub>T</sub> I1, I2, I3, I <sub>n</sub>

\* Values, only visible on Source [2]



## 7.3. Control circuits

### 7.3.1. Typical ATyS p wiring

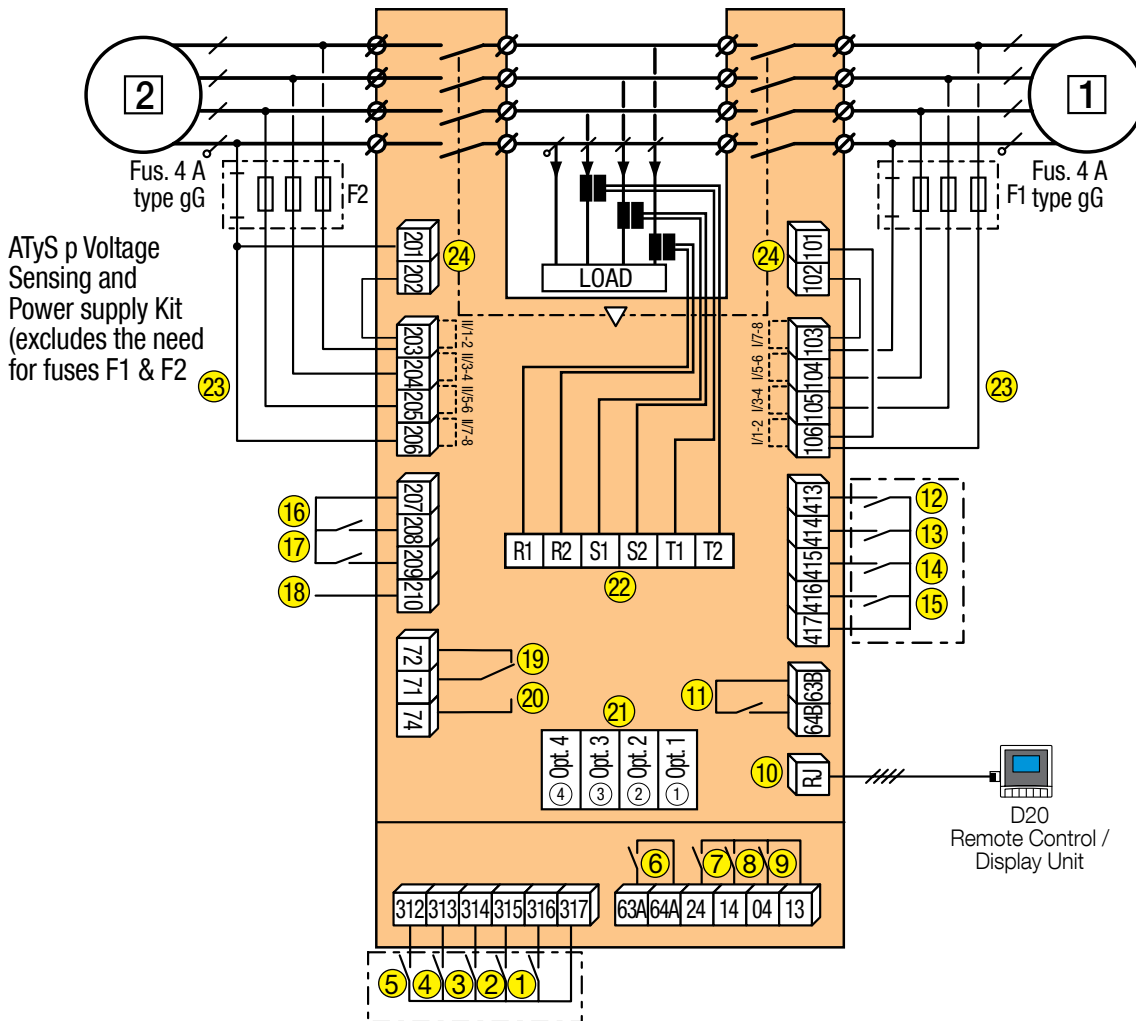

Example: Control wiring for a 400 VAC application having a 3 phase and neutral supply.



- 1 preferred source 2 alternate source  
 1. Position 0 order  
 2. Position I order  
 3. Position II order  
 4. Zero position priority order  
 5. Remote Control Enable (Priority over Auto)  
 6. Product Available output (Motor)  
 7. Position II aux contact  
 8. Position I aux contact  
 9. Position 0 aux contact  
 10. O/P to D20 remote unit

11. Programmable Output Contact.  
 By default set to ATS Product Available - Normally Open  
 12-15. Programmable Inputs 1-4  
 16-17. Programmable Inputs 5-6  
 18. Aux. Supply (207/210) to be used with ATyS optional I/O modules  
 19-20. Genset starting and stopping order  
 21. Option Module Slots 1 to 4  
 22. Current Transformer incoming cable connections  
 23. Voltage sensing inputs  
 24. Power supply Inputs

Control	71/72 (19)	71/74 (20)
Generator starting	Contact closed	Contact open
Generator stop-ping	Contact open	Contact closed

 <b>CAUTION</b>	Verify that the Auxiliary power supply feeding terminals 101 and 102 / (201 and 202) are within the limits of 208 VAC -> 277 VAC ±20%
 <b>DANGER</b>	Do not handle any control or power cables connected to the ATyS when voltage may be present.

## 7.3.2. ATyS p input and output contacts

### 7.3.2.1. Motorisation module wiring



All pressure on the connector pins is to be avoided during wiring of the auxiliary cables

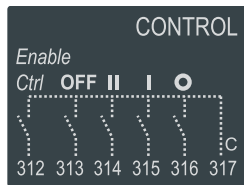

Control Enable:	312	Prod Avail Common	63A
Override to OFF:	313	Prod Avail O/P:	64A
Sw to Pos II I/P:	314	Pos II Aux Contact:	24
Sw to Pos I I/P:	315	Pos I Aux Contact:	14
Sw to Pos 0 I/P:	316	Pos 0 Aux Contact:	04
Common:	317	Common:	13

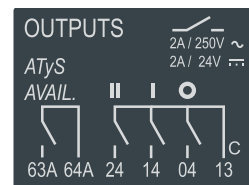

### 7.3.2.2. ATS control module wiring

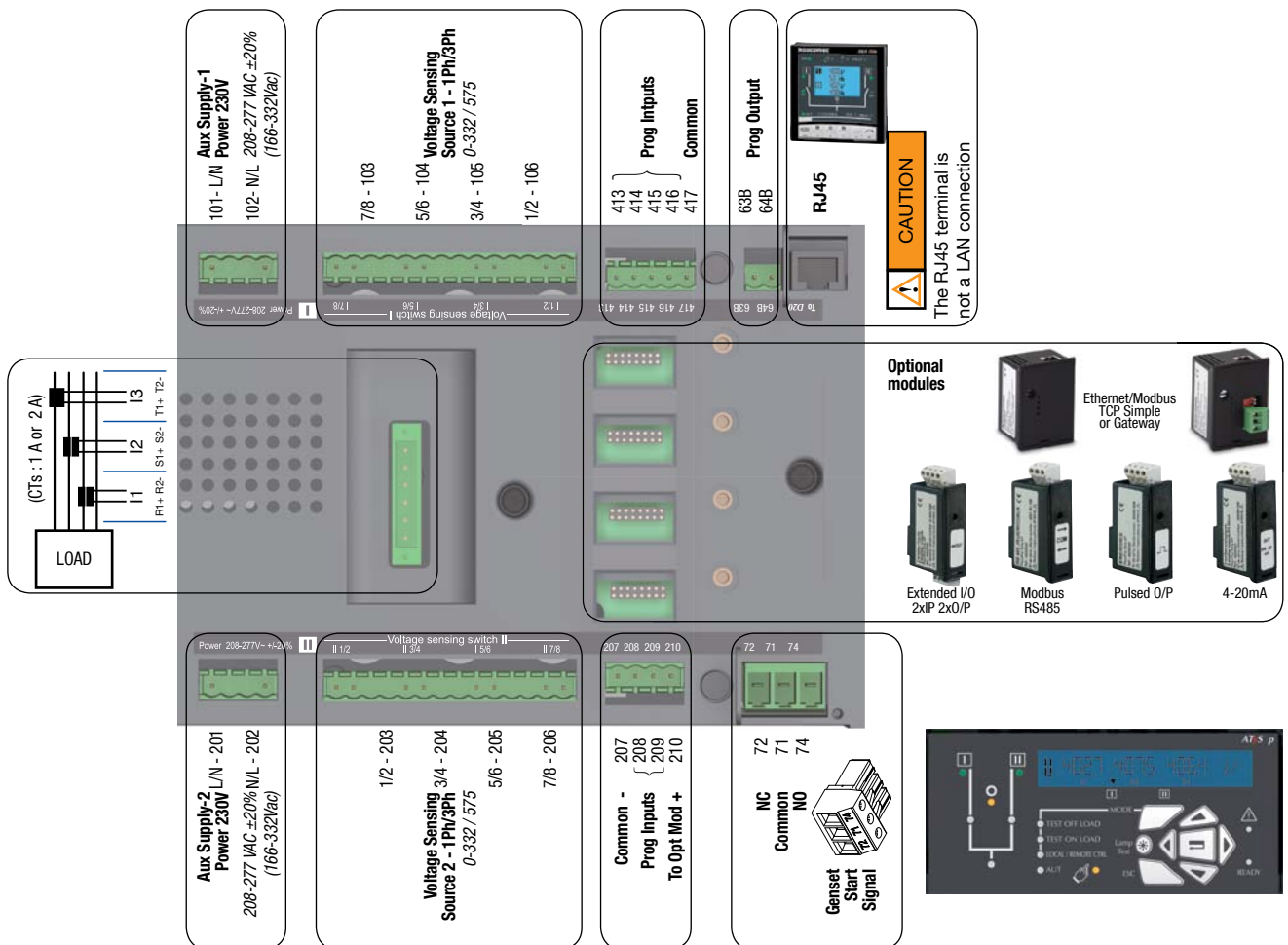

### 7.3.2.3. ATyS p (Optional Module) Input / Output Wiring Connections

The ATyS p can accept a total of 4 plug in I/O modules. (Attn: If using a communication module the total slots available for extension I/O modules may be reduced to a maximum of 3 with MODBUS RTU and 2 with the Ethernet module installed).

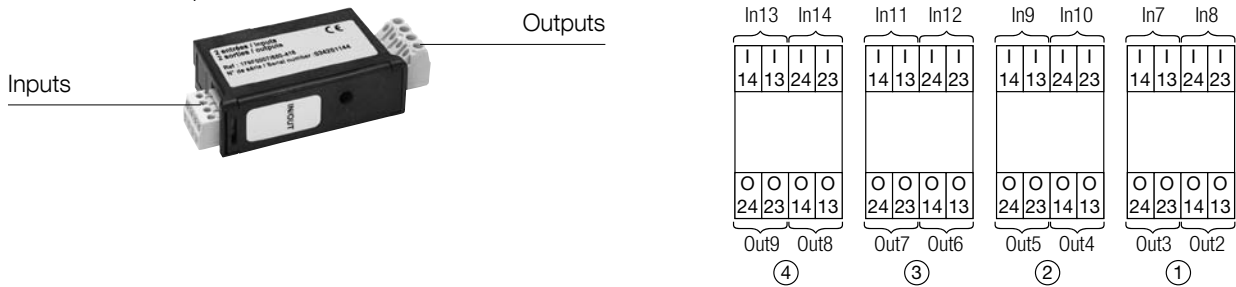

### 7.3.2.4. Terminal denomination, description and characteristics.

Denomination	Terminal	Description	Characteristics	Recommended Cable Section
<b>Output Contacts (Motorisation Module)</b>	04	Aux Contact Position 0 - Normally Open Contact	Dry Contacts 2 A AC1 / 250V 2A / 24VDC	1.5 – 2.5 mm <sup>2</sup>
	13	Common for Aux Contacts positions I - 0 - II		
	14	Aux Contact position I: Normally Open Contact		
	24	Aux Contact position II: Normally Open Contact		
	63A 64A	Motorisation module available output. Closed when the ATyS p is in Auto mode and motorisation is operational. <i>(No Fault powered and ready to changeover)</i>		
<b>ATS Output Contact</b>	63B	Programmable output dry contacts. (By default set as POP à ATS control module available output, closed when the ATyS p is in Auto mode and ATS is operational. <i>(No Fault, powered and ready for a changeover sequence)</i> )	Dry Contacts 2 A AC1 / 250V	1.5 – 2.5 mm <sup>2</sup>
	64B			
<b>Genset Start/ Stop Signal</b>	71	Signal to Start / Stop the Genset: Common for 72 & 74	Dry Contacts 2 A AC1 / 250V	1.5 – 2.5 mm <sup>2</sup>
	72	Signal to Start / Stop the Genset: NC contact. (71/72)		
	74	Signal to Start / Stop the Genset: NO contact. (71/74)		
<b>Additional Aux Contact</b>  <i>Included with 2000 A to 3200 A</i>	81	Common for Aux Contacts positions I	Dry Contacts 2 A AC1 / 250V	1.5 – 2.5 mm <sup>2</sup>
	82	Aux Contact position I: Normally Closed Contact		
	84	Aux Contact position I: Normally Open Contact		
	91	Common for Aux Contacts positions II		
	92	Aux Contact position II: Normally Closed Contact		
<b>ATS Power supply Input I</b>	101 - L/N	Power supply I – L/N	208 - 277VAC ± 20%: 50/60Hz	1.5 – 2.5 mm <sup>2</sup>
	102 - N/L	Power supply I – N/L		
<b>ATS Voltage Sensing Input*</b>  <b>Switch I</b>	103 - 7/8	Phase or neutral connected on power contact 7 or 8 of Switch I	575 VAC (ph-ph) max  332Vac (ph-n) max	1.5 – 2.5 mm <sup>2</sup>
	104 - 5/6	Phase connected on power contact 5 or 6 of Switch I		
	105 - 3/4	Phase connected on power contact 3 or 4 of Switch I		
	106 - 1/2	Phase or neutral connected on power contact 1 or 2 of Switch I		
<b>ATS Power supply Input II</b>	201 - L/N	Power supply II – L/N	208 - 277VAC ± 20%: 50/60Hz	1.5 – 2.5 mm <sup>2</sup>
	202 - N/L	Power supply II – N/L		

Denomination	Terminal	Description	Characteristics	Recommended Cable Section
<b>ATS Voltage Sensing Input*</b>  <b>Switch II</b>	203 - 1/2	Phase or neutral connected on power contact 1 or 2 of Switch II	575 Vac (ph-ph) max  332Vac (ph-n) max	1.5 – 2.5 mm <sup>2</sup>
	204 - 3/4	Phase connected on power contact 3 or 4 of Switch II		
	205 - 5/6	Phase connected on power contact 5 or 6 of Switch II		
	206 - 7/8	Phase or neutral connected on power contact 7 or 8 of Switch II		
<b>ATS Module</b>  <b>Programmable Inputs</b>	207 -	Common control terminal for inputs 5 & 6, 208 – 209 and negative for optional module extension I/O supply	<b>Attn:</b> To be used with dry contacts fed from 207 ONLY.	1.5 – 2.5 mm <sup>2</sup>
	208	Programmable Input number 5		
	209	Programmable Input number 6		
	210 +	+ dc Power supply for optional module extension I/O supply	To Ext I/O Only	
<b>Motorisation Module</b>  <b>Control Inputs</b>	312	Remote Control Mode Enable when closed with 317	<b>Attn:</b> Do not connect to any Power supply  Max cable length 100m	1.5 – 2.5 mm <sup>2</sup>
	313	Position 0 order if closed with 317. (Priority order input forcing the product to remote control mode and 0 position)		
	314	Position II order if closed with 317		
	315	Position I order if closed with 317		
	316	Position 0 order if closed with 317		
	317	Common control terminal for 312 - 316 ATyS (Specific Voltage Supply)		
<b>ATS Module</b>  <b>Programmable Inputs</b>	413	Programmable Input number 1	Do not connect to any power supply.  <b>Attn:</b> To be used with dry contacts fed from 417 ONLY.	1.5 – 2.5 mm <sup>2</sup>
	414	Programmable Input number 2		
	415	Programmable Input number 3		
	416	Programmable Input number 4		
	417	Common supply for programmable inputs 1 to 4 (413 - 416)		
<b>Remote Interface</b>	RJ	Output to D20 remote control & display module	Up to 3m	RJ 45
<b>I/O Extension Modules</b>  <b>2xInput</b> <b>2xOutput</b>	I 13+	Programmable Input	To be powered from terminals 207 – 210  10 – 30 VDC	1.5 – 2.5 mm <sup>2</sup>
	I 14 -			
<b>(Optional)</b>	I 23 +	Programmable Input	Dry Contacts 2 A AC1 / 250V	1.5 – 2.5 mm <sup>2</sup>
	I 24 -			
	O 13	Programmable Output		
	O 14			
O 23	Programmable Output			
O 24				
<b>MODBUS Module (Optional)</b>	0	RS 485 MODBUS Communication module terminals		
	-			
	+			
<b>Current transformers*</b>	R1	Current Transformer:- I1	CT Input 2 A or 1 A	1.5 mm <sup>2</sup>
	R2			
	S1	Current Transformer:- I2		
	S2			
	T1	Current Transformer:- I3		
	T2			

\*For metering and sensing details, please refer to page 40.

	CAUTION	Do not connect terminals 312 to 317, 413 to 417 or 207 to 209 to any power supply. These order inputs are powered through terminal 207 (317 or 417 respectively) and external dry contacts ONLY.
---	---------	--

## 7.4. Voltage sensing and power supply kit

The ATyS p voltage sensing kit is available as an accessory and is designed to tap directly of the power section on Switch I and Switch II terminals without the need to add protection fuses. The sensing kit is designed with optimised cable lengths and utilises silicon conductors held safely in an isolated mechanical support.

**Frame B3 - B5 - 125 A - 630 A**

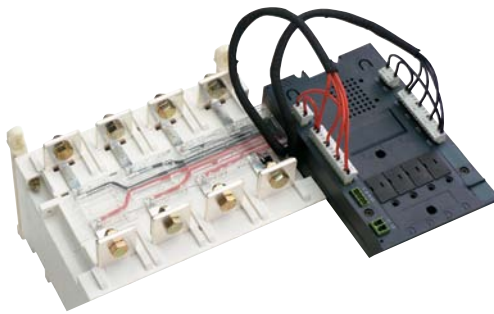
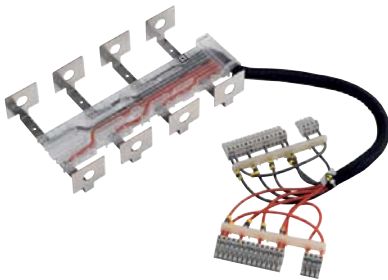

**Frame B6 - B8 - 800 A - 3200 A**

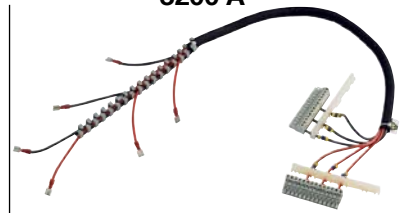

**CAUTION**

Ensure to mount the kit onto the product before connecting the power cables.

Be careful not to damage the contacts during kit mounting and during power cables connections (Tighten the cables carefully).

### 7.4.1. Standard configuration

The sensing and power supply kit may be ordered in 3 phases network 4 wires or 3 wires.

It can be used with top or bottom cables entry. The only connection to respect is that measures of the source on Switch I must be connected to the inputs located on the right of the electronic module and the measures of the source on Switch II must be connected to the inputs located on the left of the electronic module.

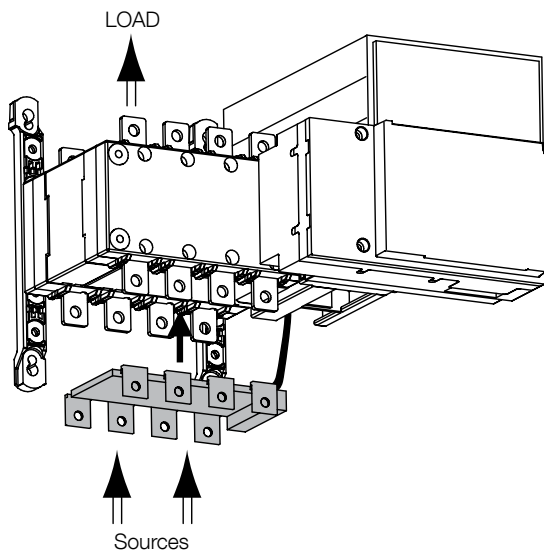

**CAUTION**

Pay attention when wiring the power cables (Respect to the sensing kit legend)

3 wire kits (those without a neutral) do not include for the power supply to terminals. (101-102 and 201 - 202)

Ensure that you have ordered the correct reference prior to installation.

(Refer to the accessory section for details).

## 7.4.2. Sensing kit wiring diagram (standard)

### Bottom incoming with Top Outgoing

- Black Wires -> Switch I
- Red Wires -> Switch II

### Wiring numbers:

Wire numbering has been determined in accordance to the power switch terminals

### Top Incoming with Bottom Outgoing

- Black Wires -> Switch II
- Red Wires -> Switch I

### Example:

Black and red wire numbers 1-2 are always connected to terminals 1 or 2 from switch I or II

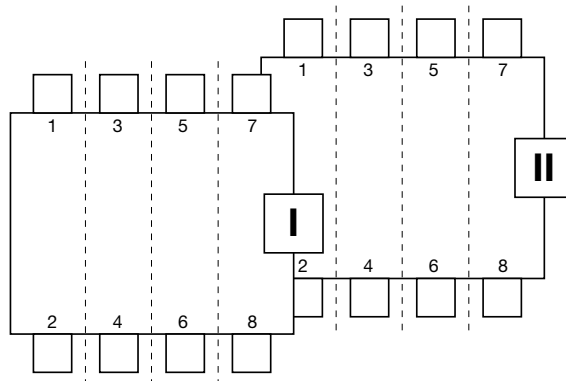

**CAUTION**

Verify kit orientation before mounting the kit.  
Kit output cables always on the right hand side (control module side).

≤ 630 A Bottom view

≥ 800 A Bottom view

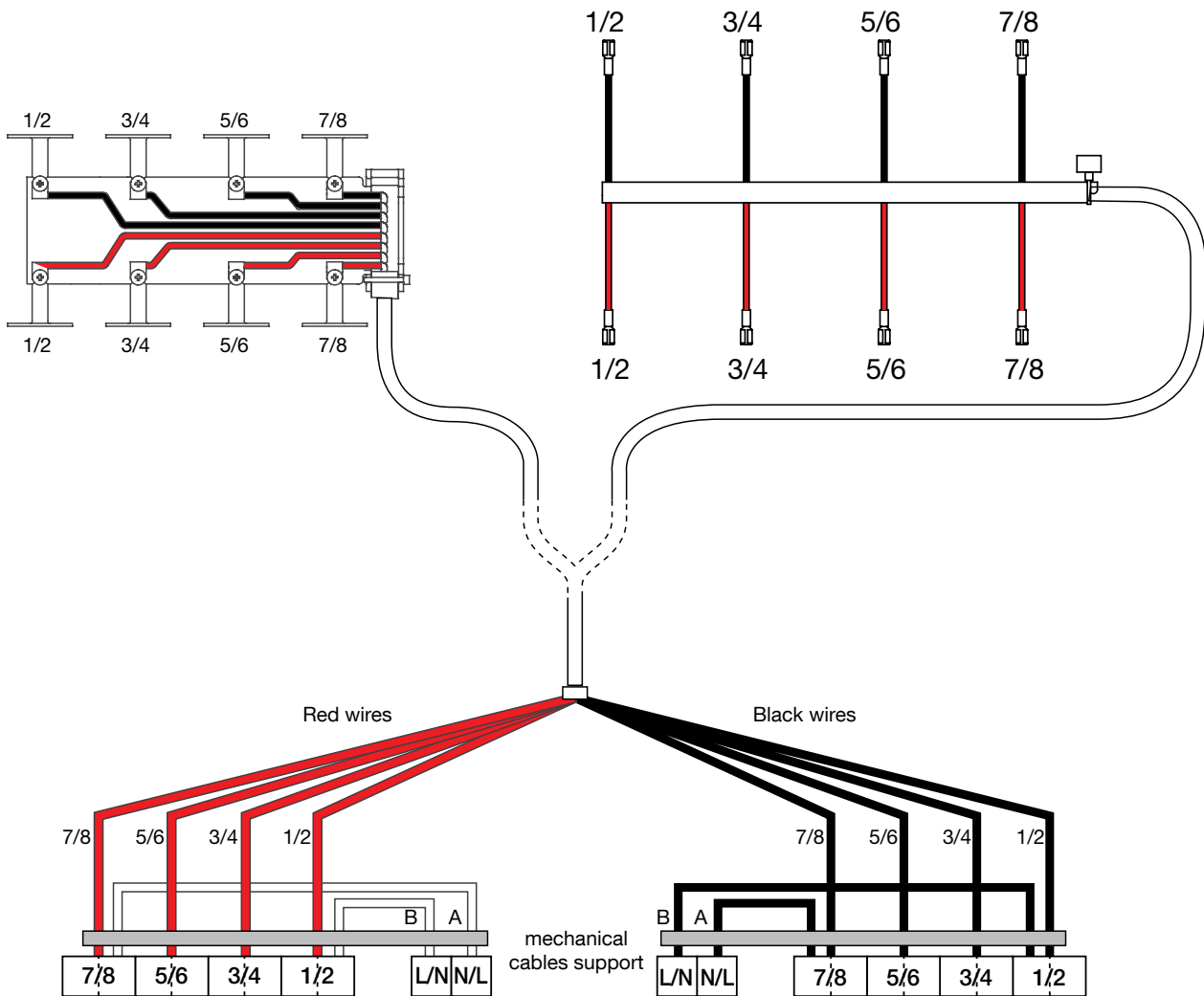

### 7.4.3. Network

Power inputs (terminals 101-102 & 201-202) are 220/240/277 VAC (208 - 277VAC) ± 20%. It is necessary to adapt the power input cable connections according to the network configuration. (Power supply to be taken between phase to phase or between phase and neutral).

	<b>CAUTION</b>	<p>Verify that the power supply between terminals 101 – 102 and 201 – 202 (nominal auxiliary voltage supply) is within 208-277VAC ± 20%.</p>
---	----------------	--

- Standard kit:

Network 380/415 VAC ± 20% with neutral conductor (no kit modification required):

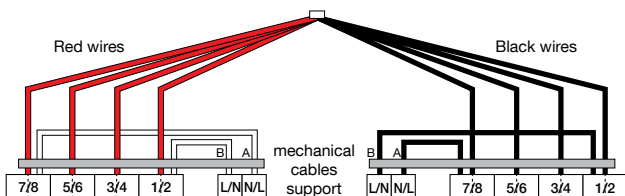

- Kit Modification:

For network 220/240 VAC ± 20%, power supply cables A-B to connect between phases

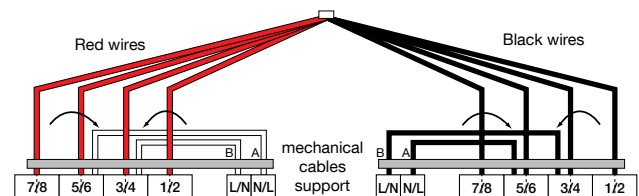

### 7.4.4. Priority source connected on switch I or II (M-G Application)

Certain applications or installation constraints may require that the main supply is connected to switch II instead of switch I. This is possible to cater for with certain precautions.

The ATyS p includes the facility to adapt the switch priority supply using the configuration in the software that will swap the main supply and switch logic (S1 = SW2 in SETUP Menu). When this is done pay attention to the LED switch position display that will no longer correspond to the identification labels on the switch. The LED's will correspond to the switch that is energized however the main supply will be displayed under II. In this case it is important to update the ATS controller sticker so as to correspond with the actual wiring and configuration.

**Change from:**

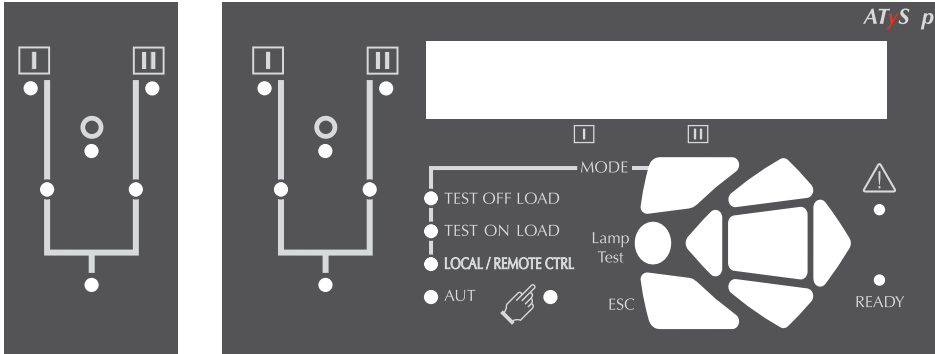

**Source 1 on switch I:**  
Standard configuration.

**to:**

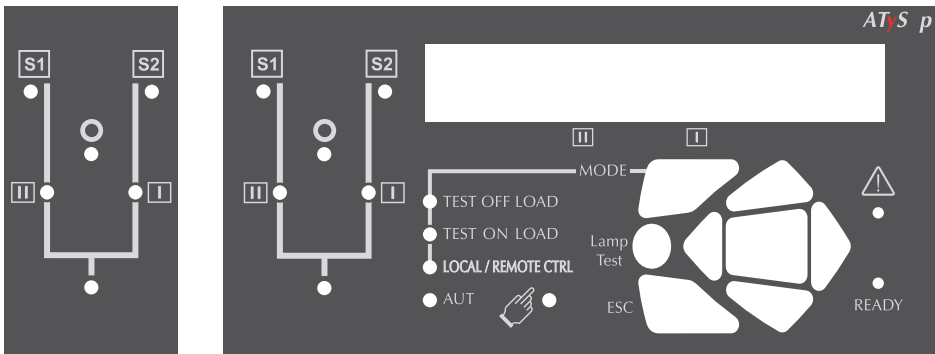

**Source 1 on switch II:**  
Set parameter S1=SW2 at YES, in SETUP menu

S1=SW2    YES



**CAUTION**

When reversing the switch priority (main supply connected to switch II) update the LED numbering on the front of the ATS to correspond with the actual wiring, configuration and LED indication.  
Inverse (I – II -> II – I)

**BOTTOM: SOURCE CABLE ENTRY**

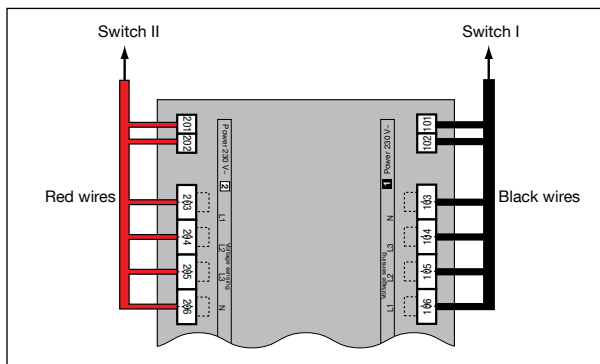

**TOP: SOURCE CABLE ENTRY**

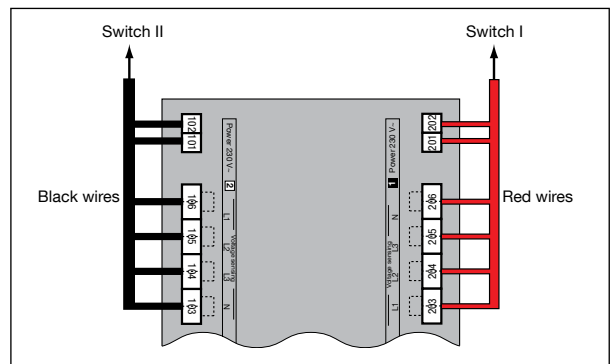











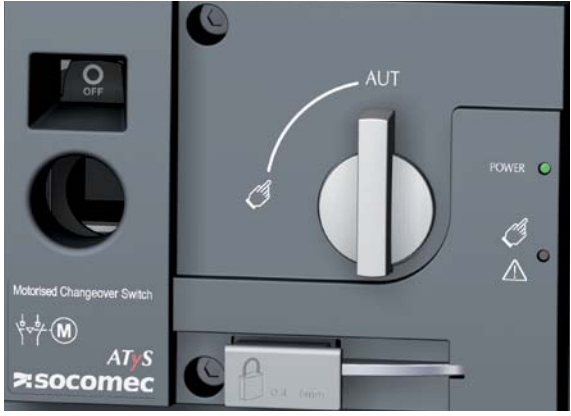



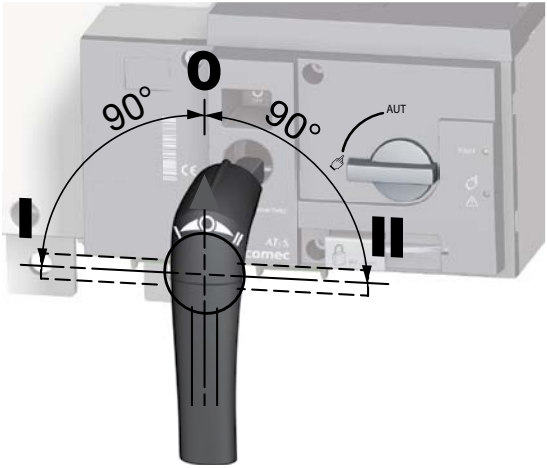

# 8. OPERATING MODES

The ATyS p includes 3 safe and distinct operating modes through a selector switch located on the front of the product. As standard the ATyS p is delivered with a selector switch however a key lock type selector switch is available as an accessory.

The modes of operation are as follows:

- Auto Mode: "Auto / Remotely operated transfer switching"
- Manual Mode: "Local emergency manual operation"
- Locked Mode: "Secure locked padlocking facility"

<p><b>AUT</b> MODE</p>		<p><b>AUT</b></p>  	<p><b>AUTO MODE:</b></p> <ul style="list-style-type: none"> <li>• Activates the remote control inputs and the ATS controller automation.</li> <li>• Inhibits the padlocking facility</li> <li>• Inhibits the insertion of the manual operation handle when in AUT Mode</li> </ul> <p>AUTO Mode position is inhibited when padlocked or when the handle for manual operation is inserted into the ATyS p.</p>
<p> MODE</p>		<p><b>AUT</b></p>  	<p><b>MANUAL MODE: (Not Padlocked)</b></p> <ul style="list-style-type: none"> <li>• Inhibits the control inputs.</li> <li>• Allows to insert the handle for emergency manual operation.</li> <li>• Allows padlocking in O Position. <i>(With the handle for manual operation removed)</i></li> </ul> <p>Turning the selector switch to  from AUT and back to AUT resets a fault state.</p>
<p>  MODE</p>		<p><b>AUT</b></p>  	<p><b>MANUAL MODE: (Padlocked)</b></p> <ul style="list-style-type: none"> <li>• Inhibits the control inputs.</li> <li>• Inhibits insertion of the emergency handle.</li> <li>• Allows padlocking when in O Position.</li> </ul> <p>  POS 0</p> <p>Padlocking in position I - O and II is possible when the optional function is included in the ATyS p. (Refer to product catalogue)</p>



**WARNING**

Depending on the state of the ATyS p the ATS automation may change the switch position as soon as the mode selector is switched to AUT. This is a normal operation.

## 8.1. Manual operation

### 8.1.1. Emergency manual operation

The ATyS p can be manually operated as a “Manual Transfer Switch Equipment – MTSE” whilst retaining the electrical characteristics and performance of the power switching function. This function is usually used in case of emergencies or during maintenance.

To operate the ATyS p manually ensure that no live parts are accessible, turn the front selector switch into the manual position (see page 20) and insert the handle (see page 20) into the emergency handle shaft location hole provided (see page 21).

Turn the handle 90° clockwise or anti-clockwise (depending on the position to be reached) for each consecutive change in position. I -> O -> II -> O -> I.



**CAUTION**

Ensure to verify the product position and direction of rotation before effecting manual operation.

Ensure to remove the handle from the product before changing the selector switch back to AUT position.

### 8.1.2. Padlocking

The ATyS p can be padlocked in the 0 position as standard whilst padlocking in positions I, O or II is available as a factory fitted option.

To padlock the ATyS p first ensure that the ATyS p mode selector switch is on Manual then ensure that the emergency manual operation handle is not inserted into the location hole. (Remove if inserted).

Pull the padlocking mechanism outwards to reveal the slot for inserting up to 3x dia. 4 - 8 mm padlocks.

Padlock the device with approved quality padlocks of minimum diameter 4 mm and maximum diameter of 8 mm. A maximum of 3x 8 mm padlocks may be padlocked onto the ATyS p to padlocking mechanism.



**CAUTION**

As standard, padlocking is only made possible in the “O position”, when in manual mode and with the emergency handle not inserted.

## 8.2. Electrical operation

### 8.2.1. Dual power supply

The ATyS p includes a dual power supply and is to be powered between terminals 101 - 102 and 201 - 202 (2 different supplies - main & alternative) within the limits of: 208 - 277 VAC  $\pm$  20% / 50/60Hz  $\pm$  10%.

Current Input: 100mA (Standby mode) / 15 A max (during switching mode)

Surge Protection : Vin\_sg: 4.8KV - 1.2/50 $\mu$ s according to IEC 61010-1

Terminal connectors: Minimum 1.5 mm<sup>2</sup> / Maximum 2.5 mm<sup>2</sup>

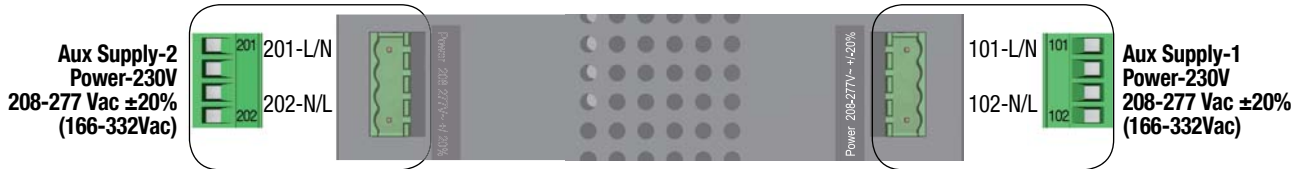

### 8.2.2. Voltage sensing inputs

The ATyS p includes dual single phase and three phase voltage sensing (terminals 103 - 106 and 203 - 206) designed to monitor 1Phase (L-N) supplies of up to 332 VAC and 3 phase (L-L) of up to 600 VAC.

The ATyS p is designed to handle single phase, three phase with neutral as well as three phase without neutral networks. Simply define the correct configuration of single or three phase during configuration through the keypad or using Easy Config software.

Sensing connections are usually tapped directly off the ATyS p power terminals using the ATyS sensing kit available as an accessory. Sensing kits are available with the neutral on the left or neutral on the right to match the network configuration where the ATyS will be operating. Refer to the ATyS accessory section for more details.

(Note: Reversal of the neutral position from left to right and vice versa may also be done through the ATyS p configuration settings).

Sensing values measured will have a direct influence on determining the availability of the main and the alternative supplies as well as the ATyS p automation.

The parameters monitored through sensing are the following:

- **Phase rotation / imbalance (3 phase networks)**

Phase imbalance in the ATyS p is relative to the nominal voltage configured in the product.

- **Frequency within set limits**

This will depend on the nominal frequency configured.

- **Loss of Neutral**

When used on three phase + neutral applications the loss of neutral will be detected for unbalanced loads with the load connected to the supply. Detection is done when the load is on.

- **Loss of the main or alternative supply.**

Loss of supply depends on the nominal voltage and frequency configured together with the hysteresis set in the product. The supply will be considered as failed after the failure timer FT has elapsed.

- **Return of main and / or alternative supply.**

Return of supply depends on the phase rotation, nominal voltage and frequency configured together with the hysteresis set. The supply will be considered as returned after the return timer RT on the ATS controller has elapsed.

Measurement accuracy: Frequency: 0.1% - Voltage: 1%



## 8.2.3. Fixed inputs

### 8.2.3.1. Description

The ATyS p includes for 5 off fixed inputs through a 6 pin connector installed on the motorisation module. No additional power supply should be used on these contacts as the inputs **MUST** be used with the common supply taken from terminal 317.

At least one of the ATyS p aux power supplies (101 – 102 or 201 - 202) must be available to activate these inputs.



Pulse duration for activation of contact inputs:  $\geq 60\text{ms}$ .

- **Pin 312:** Remote Control Mode Enable when closed with 317.  
This contact must be closed with 317 so as to activate all control inputs except for 313 that takes priority and is active immaterial of the state of input 312. Enabling remote control through 312 activates the remote control inputs whilst inhibiting the ATS module automation.
- **Pin 313:** Position 0 order if closed with 317 when in AUTO. **(Force the switch to the OFF Position)**  
This is a **“Priority Order Input”** meaning that when closed with 317 it takes priority over all other electrical commands. The ATyS p will remain in 0 position as long as the contact 313 – 317 remains closed. Once the contact is open the ATyS p is ready to receive new orders. This contact order is independent of other inputs and is also enabled without 312 connected to 317. Impulse duration to activate and start switching to position O is a minimum of 60ms. The product state will be unavailable.
- **Pin 314:** Position II order if closed with 317.  
This contact is active with the ATyS p in AUT mode with contact 312 – 317 closed and 313 – 317 open. Impulse duration to activate and switch to position II is a minimum of 60ms.
- **Pin 315:** Position I order if closed with 317  
This contact is active with the ATyS p in AUT mode with contact 312 – 317 closed and 313 – 317 open. Impulse duration to activate and switch to position I is a minimum of 60ms.
- **Pin 316:** Position O order if closed with 317  
This contact is active with the ATyS p in AUT mode with contact 312 – 317 closed and 313 – 317 open. Impulse duration to activate and switch to position O is a minimum of 60ms. For contactor logic maintain contacts on between terminal 316 and 317.
- **Pin 317:** Common  
Common supply for inputs 312 to 316

### 8.2.3.2. Remote control logic

Remote switching operation can be driven in AUT mode by external volt free contacts as described above using input contacts 312 to 317.

Depending on the wiring configuration there are two types of logic that may be applied to the ATyS p.

- Impulse logic or
- Contactor logic.

In remote control, the ATyS p inputs give priority to orders I and II over 0 therefore contactor logic can be implemented by simply bridging terminals 316 and 317.

(NOTE: 313 – 317 closed / Force ATyS to OFF Position, takes priority over all other orders no matter of the control logic used.)

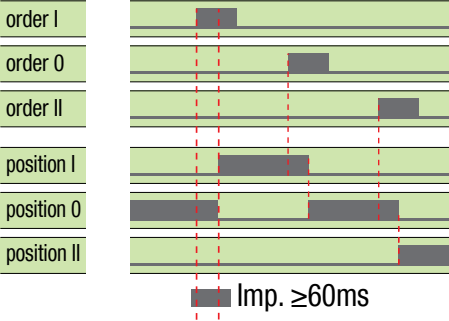
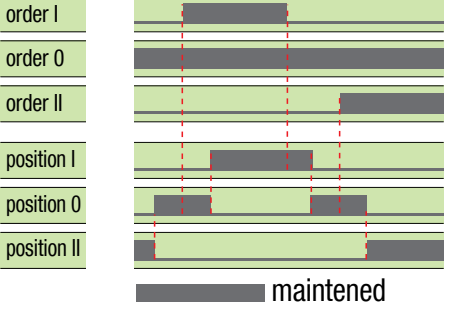
<p><b>Impulse logic:</b></p> <p>The ATyS p is driven to a stable position (I – O – II) after receiving an impulse order.</p> <ul style="list-style-type: none"> <li>• A switching command of at least 60 ms is necessary to initiate the switching operation.</li> <li>• Orders I and II have priority over order 0.</li> </ul> <p>Note: The logic diagrams exclude the transfer times.</p>	<p style="text-align: center;"><b>Impulse logic</b></p>  <p style="text-align: center;">(Note : Excludes position switching delays)</p>
<p><b>Contactor Logic:</b></p> <p>The ATyS p is driven to a specific position (I or II) for as long as the order is maintained.</p> <ul style="list-style-type: none"> <li>• Order 0 is maintained. (Bridge 316 – 317)</li> <li>• Orders I and II have priority over order 0.</li> <li>• Orders I and II have equal priority. (1st order received is held until no longer maintained).</li> <li>• If order I or II disappears, the device returns to zero position. (With the power supply available).</li> </ul>	<p style="text-align: center;"><b>Contactor logic</b></p>  <p style="text-align: center;">(Note : Excludes position switching delays)</p>

### 8.2.4. Programmable inputs

#### 8.2.4.1. Description

Configuration of all programmable inputs is recommended to be done using the EasyConfig Software available for download on the Socomec Website. Communication with the ATyS p is possible either through the Modbus or Ethernet modules that are available as an option. Alternatively the parameters may also be configured directly through the keypad on the front of the ATS controller.

- **Pin 413:** Input In1, Programmable Input 1
- **Pin 414:** Input In2 , Programmable Input 2
- **Pin 415:** Input In3, Programmable Input 3
- **Pin 416:** Input In4, Programmable Input 4
- **Pin 417:** Common. Common supply for programmable inputs 1 – 4 on terminals 413 to 416.
- **Pin 207:** Common. Common supply for programmable inputs 5 – 6 on terminals 208 to 209.
- **Pin 208:** Input In5, Programmable Input 5
- **Pin 209:** Input In6, Programmable Input 6

NOTE: Details of the programmable inputs, see page 94.

### 8.2.4.2. Technical data

	Motorisation Module	ATS Control Module
Input Qty	5	6
Direct Current Iin	0.35 to 0.5mA	1 to 2.5mA
Line resistance	1kΩ	1kΩ
Line length	100m (Min. wire 1.5 mm <sup>2</sup> #16AWG)	100m (Min. wire 1.5 mm <sup>2</sup> #16AWG)
Pulse duration	60ms	60ms
Power per Input	0.06VA	0.03VA
Surge protection Vin_sg	4.8kV (1.2/50μs surge)	2.4kV (1.2/50μs surge)
ESD withstand voltage (Contact/air)	2/4kV	2/4kV
Insulation (Common mode)	4.8kVAC (Between I/P and all common parts)	4.8kVAC (Between I/P and all common parts)
Terminal connector	1.5 mm <sup>2</sup> minimum / 2.5 mm <sup>2</sup> max	1.5 mm <sup>2</sup> minimum / 2.5 mm <sup>2</sup> max

### 8.2.5. Fixed outputs - Dry contacts

#### 8.2.5.1. Description

As standard, the ATyS p is equipped with four fixed outputs located on the motorisation module.

(Dry contacts to be powered by the user).

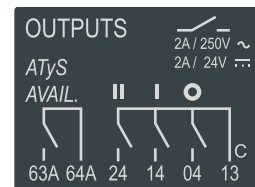

#### 8.2.5.2. Position auxiliary contact

The ATyS p is equipped with integrated position (I – O – II) auxiliary contact outputs through 3 off micro switches.

#### Pins 13, 04, 14, 24

(Normally Open contacts with pin 13 as common)

#### 8.2.5.3. ATyS p Product available output (motorisation)

##### Pin 63A – 64A

(Normally Open contact that is held closed when the motorisation is available).

This contact gives constant feedback about the product's availability and it's capacity to transfer from the main supply to the alternative. The feedback given is relative to the motorisation module excluding the ATS controller that may be monitored separately.

The ATyS p performs a self diagnostics test on the motorisation module at startup, when put from Manual -> Auto and then every 5 minutes. This test ensures that the ATyS p is operational in terms of control inputs. Should one of the tests fail, a second test is performed to reconfirm the error state. Should the ATyS p motorisation module become unavailable, contact 63A – 64A are opened, the power/ready LED's are switched off, and the fault LED is activated. The fault LED will remain active for as long as sufficient power is available and the fault condition is not reset. The fault is reset when the product is switched from AUT -> Manual -> Auto mode.

ATyS p (Motorisation) Product Available / Unavailable Watchdog relay will open for any of the following reasons below: For added security, "Product Availability" is informative and does not necessarily inhibit motor operation.

Product Unavailable + Warning LED Condition:	Inhibition
Product in manual mode	Yes
Motor not detected (Autotest)	No
Control voltage out of range	Yes
Operating factor fault active (N° of operations / min)	Yes
Powerfail active	Yes

Customer input autotest failed	No
Abnormal switching when not in manual mode	Yes
Requested position not reached	Yes
Locked mode active when not in manual mode	Yes
External Fault -> User input	No
Unexpected current flowing through the motor when idle	Yes

Sampling rate for the above is every 10 ms

Exception: motor detection sampling rate is every 5 min

#### 8.2.5.4. Technical data

Auxiliary Contact Quantity	4
Configuration	NO
Mechanical Endurance	100k cycles
Response Time	5 – 10 ms
Startup duration	200ms
Rated Voltage / Switching Voltage	250 VAC
Rated Current	2 A
Surge protection Vin_sg:	4.8kV (1.2/50µs surge)
ESD withstand voltage (Contact/air):	2/4kV
Dielectric Strength contact/parts:	4.8kVAC (Reinforced Insulation)
Insulation:	4.8KVAC
Output Terminal:	1.5 mm <sup>2</sup> minimum / 2.5 mm <sup>2</sup> maximum

#### 8.2.6. Programmable dry contact output

##### Pin 63B – 64B: Output Out1

- Output "Out 1", Programmable Output 1 is set by default as a Product Available Output for the ATS controller module.

To achieve a single product feedback connect this contact in series with 63A – 64A. (Normally Open contact that is held closed when the ATS is available). Being programmable this output may be changed to any other normally open or normally closed output as available in the product.

NOTE: Details of the programmable outputs, see page 97.

The ATyS p may accept a total of 4 additional Input / Output modules offering an additional 8 programmable inputs and 8 programmable outputs.

Refer to accessory section for details:

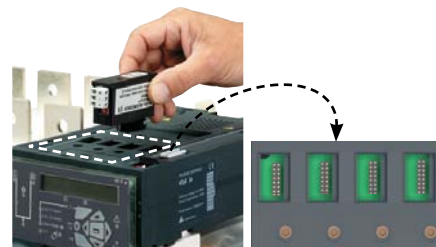

##### Note:

For pulsed outputs and 4-20mA output refer to specific optional module instruction manual on [www.socomec.com](http://www.socomec.com).

## 9. PROGRAMMING

The ATyS p is to be programmed powered up and after wiring verification tests. This may either be done through the front of the ATS Controller using the keypad or with the user-friendly Easy Config software.

For convenience, we recommend to use the Easy Config software.  
(Downloadable free from [www.socomec.com](http://www.socomec.com))

Communication between the software and the ATyS p may be done through the Ethernet/Modbus TCP or Modbus RTU modules that are available as an option. (The Ethernet module includes a built in Web Server).

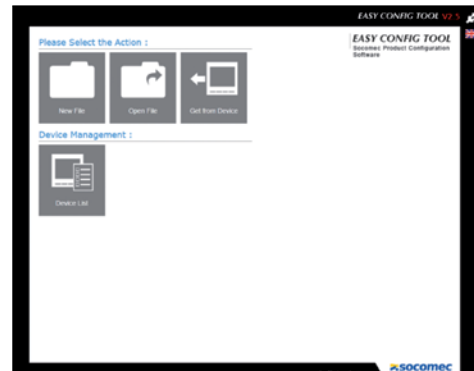

*Configuration through the Keypad or Easy Config Configuration Software*

### 9.1. Programming with Easy Config software

The ATyS p is recommended to be configured using the latest version of SOCOMEC Easy Config software. Easy Config is a software developed by SOCOMEC to enable the easy configuration of most of Socomec products.

Communication between the software tools and a powered up product may be done using a standard PC together with the ATyS p equipped with an optional Ethernet or Modbus module.



The configuration may be carried out connected to the product as well as off line. When configuring the product offline input the setting values as per requirements in the Easy Config software and save the file.

You may download the complete file into the ATyS p at your convenience either before delivering the product to site or when the product is ready for commissioning. The same settings may easily be downloaded to multiple products that have the same configuration requirements.

#### 9.1.1. Download and install Easy Config Software

Download the latest Easy Config software from the Product Download section of the SOCOMEC Website:  
[www.socomec.com](http://www.socomec.com)



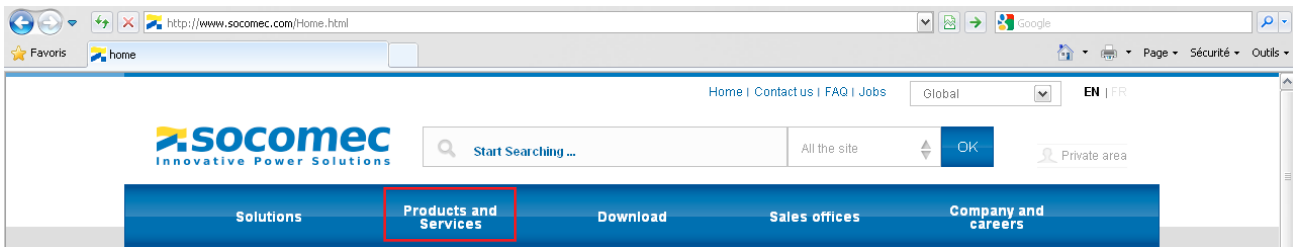

- Run the program on your computer and follow the instructions so as to install the Software. Once installed, open the software by clicking on: Start -> All Programs -> Socomec -> EasyConfig. The software is best viewed with a resolution of 1280 x 1024
- Select your language from the drop box on the top, right hand side of the screen.

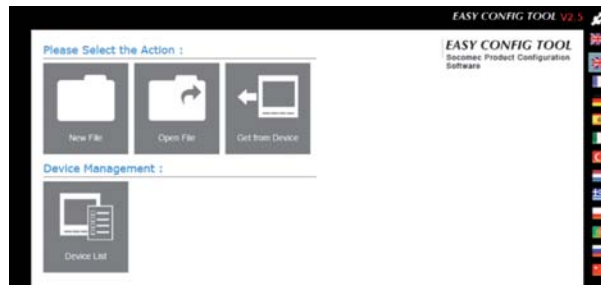

- A user with rights may change profile and access advanced settings by clicking on “Change Profile” This allows to select a profile from a User / Administrator / Super User / Socomec. The SOCOMECE profile is only available for SOCOMECE internal use. Change of profile will require a password that may be set by the User

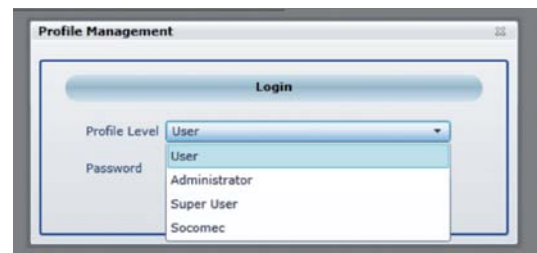

Profile	Functions that may be perform	Password by Default
User	<ol style="list-style-type: none"> <li>1. User can add a device in the Easy Config Tool.</li> <li>2. User can get the configuration from a device.</li> <li>3. User can create a new configuration for the device.</li> </ol>	No password is required for this profile
Administrator	<ol style="list-style-type: none"> <li>1. All the function that a user can perform +</li> <li>2. User can send configuration to the device.</li> <li>3. User can delete a declared device.</li> <li>4. User can update the device connection parameters.</li> </ol>	Password by default : SocoAdm
Super User	<ol style="list-style-type: none"> <li>1. All the function that Administrator can perform +</li> <li>2. The User can change and save the passwords for the Administrator and the Super User.</li> </ol>	Password by default : sOcOmece
Socomec	<ol style="list-style-type: none"> <li>1. Not Used</li> </ol>	Not Used

**Refer to specific Easyconfig instruction manual on [www. socomec.com](http://www.socomec.com) for details regarding Easy Config Programming.**

## 9.2. Programming with the ATyS p keypad

ATyS p devices may also be programmed through the ATS controller keypad. This programming method is necessary for products not equipped with Ethernet or Modbus communication modules that facilitate programming through Easy Config software described above. The keypad is a useful interface and programming method most especially when changing a few parameters or simply interrogating the product.

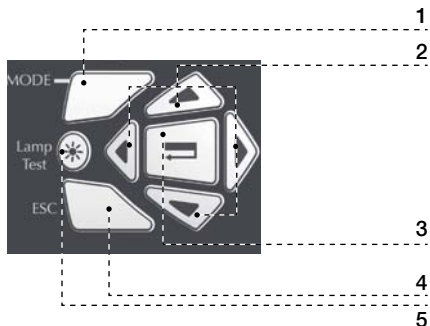

1. MODE key to shift between operation modes.
2. Navigation Keys to browse through the ATyS p menus without software.
3. Enter Key used to enter Prog Mode (Press and hold for 5 seconds) and to validate the settings programmed through the keypad.
4. ESC key used to escape from a specific screen up to the main menu.
5. Lamp test key to check the LED's and LCD screen.

Programming access through the keypad is possible in Automatic or Manual mode, when the product is in a stable position (I, 0 or II) with at least one supply source available.

Programming is not accessible whilst any cycle sequence is running.

### NOTE:

The ATyS p is delivered with default setting values based on most used customer application requirements. Should the user not need to fine tune all the parameters this will allow for a quick setup of the ATyS p. The minimum configuration parameters that must be programmed are the type of network and application together with the voltage and frequency nominal values.

**Refer to Annexe II page 81 for details regarding Programming with the ATyS p Keypad.**

## 10. The LCD Display

### 10.1. Presentation

Display mode is activated as soon as the device is switched on. It enables parameter visualisation whatever the functioning mode that is running. The switchover cycles take priority over any other display, and will show the time delay countdowns as soon as they are activated. After this time, or following a switchover cycle, the screen will return to source 1 (depending on the switch position) phase to phase voltage display (depending on the network type).



## 10.2. Display mode navigation and visualisation

1	2	3	4	5	6	7
Voltage	Current	Power	Energy	Timers	Date/Time	Events
U 0 0 0 V (1) 1-2 2-3 3-1	I 0 0 0 A 1 2 3	P 0 0 0 kW (3) 1 2 3	EA+ TOT 0 kWh (3) I	1FT 0 SEC	DAT 01.01.01	F00 OPFACTOR
U 0 0 0 V (1) 1 2 3	I NEUTRAL 0 A I	P TOTAL 0 kW (3) I	EA- TOT 0 kWh (3) I	1RT 0 SEC	TIM 01.01.01	F03 NEUTRAL
F 0 Hz (1) I	I 0 0 0 A 1 2 3	Q 0 0 0 kvar (3) 1 2 3	EQ+ TOT 0 kvarh (3) I	2FT 0 SEC		F11 FLT 1
U 0 0 0 V (1) 1-2 2-3 3-1	I NEUTRAL 0 A I	Q TOTAL 0 kvar (3) I	EQ- TOT 0 kvarh (3) I	2AT 0 SEC (2)		F21 FLT 2
U 0 0 0 V (1) 1 2 3		S 0 0 0 kVA (3) 1 2 3	ES TOT 0 kWh (3) I	2CT 0 SEC		F12 ALR 1
F 0 Hz (1) I		S TOTAL 0 kVA (3) I	EA+ PAR 0 kWh (3) I	ODT 0 SEC		F22 ALR 2
		PF 0 0 0 (3) 1 2 3	EA- PAR 0 kWh (3) I	TOT 0 SEC		F13 ROT 1
		PF TOTAL 0 (3) I	EQ+ PAR 0 kvarh (3) I	TFT 0 SEC		F23 ROT 2
		P 0 0 0 kW (3) 1 2 3	EQ- PAR 0 kvarh (3) I	E1T 0 SEC		F17 UNB 1
		P TOTAL 0 kW (3) I	ES PAR 0 kWh (3) I	E2T 0 SEC		F27 UNB 2
		Q 0 0 0 kvar (3) 1 2 3	EA+ COM 0 kWh (3) I	E3T 0 SEC		F06 POS 0
		Q TOTAL 0 kvar (3) I	EA- COM 0 kWh (3) I	E5T 0 SEC		F16 POS 1
		S 0 0 0 kVA (3) 1 2 3	EQ+ COM 0 kvarh (3) I	E6T 0 SEC		F26 POS 2
		S TOTAL 0 kVA (3) I	EQ- COM 0 kvarh (3) I	E7T 0 SEC		F08 MAIN FLT
		PF 0 0 0 (3) 1 2 3	ES COM 0 kWh (3) I	T3T 0 SEC		F09 MOT FLT
		PF TOTAL 0 (3) I	EA+ TOT 0 kWh (3) I	2ST 0 SEC		F07 AUTOCONF
			EA- TOT 0 kWh (3) I	LST 0 SEC		EV1 ID
			EQ+ TOT 0 kvarh (3) I	EET 0 H		EV1 DAT 01.01.01
			EQ- TOT 0 kvarh (3) I	EDT 0 SEC		EV1 TIM 00.00.00
			ES TOT 0 kWh (3) I			EV2 ID
			EA+ PAR 0 kWh (3) I			EV2 DAT 01.01.01
			EA- PAR 0 kWh (3) I			EV2 TIM 00.00.00
			EQ+ PAR 0 kvarh (3) I			EV3 ID
			EQ- PAR 0 kvarh (3) I			EV3 DAT 01.01.01
			ES PAR 0 kWh (3) I			EV3 TIM 00.00.00
			EA+ COM 0 kWh (3) I			EV4 ID
			EA- COM 0 kWh (3) I			EV4 DAT 01.01.01
			EQ+ COM 0 kvarh (3) I			EV4 TIM 00.00.00
			EQ- COM 0 kvarh (3) I			EV5 ID
			ES COM 0 kWh (3) I			EV5 DAT 01.01.01
						EV5 TIM 00.00.00

Unbalanced % is not displayed

- (1) Visibility depends of configured network type
- (2) Should be named 2RT when main-main application
- (3) Units are adjusted automatically

Powers are only displayed for current switch position

**Note** : for events display code identification, refer to «Events display», page 72



### CAUTION

Dynamic display of the time delays takes priority.  
The alarms and fault status display also have priority.

## 10.3. IHM D10 / D20

Refer to D10 / D20 operating manual on [www.socomec.com](http://www.socomec.com)

# 11. Local / remote control (positions I – 0 – II)

Local control will allow the user to change position locally without the need for the emergency manual handle. This function is available in AUT mode only.

**Description:**

- Changeover of the switch positions: PS1, PS0, PS2.

**Activation:**

- either on the ATyS p front panel (via the Mode key),
- or via the D20 interface,
- or via the programmable input,
- or via communication. (Ethernet or MODBUS).

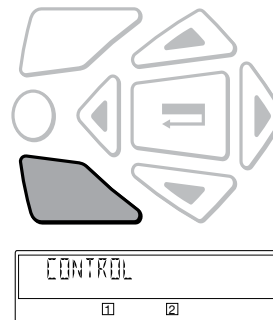

**Steps:**

- Select Local / Remote mode using the Mode key
- When Control is displayed press the validation key
- Enter the password when prompted with CODE (Default 0000)
- Press the validation key to validate the password and access the position menu
- To change from POS0 to POS1 to POS2 etc press the MODE key to select the desired position.
- YES and NO define the actual position that the switch will be in.

**To change position: example**

- POS2 NO (This states that the switch is not in position II)
- To go to position II press the validation key with POS2 NO on the display
- Once position II has been reached the display will change to POS2 YES

**Deactivation:**

- either via the Escape key,
- or by switching the selector switch on the front of the ATyS p from AUT to Manual and back to AUT.

**Note:** Local / Remote Control takes priority over all other operating functions.

# 12. Automatic mode

Set the selector switch on the front of the ATyS p onto AUT. Make sure that the product is in automatic mode with the AUT LED lit green.

**Possible action when in AUT MODE**

Once in automatic mode, it is possible to:

- Run an on load or off load test.
- Run a source 1 / source 2 loss sequence.
- Start a source 1 / source 2 restoration sequence.

## 12.1. Manual & Automatic Mode / Mains restoration conditions

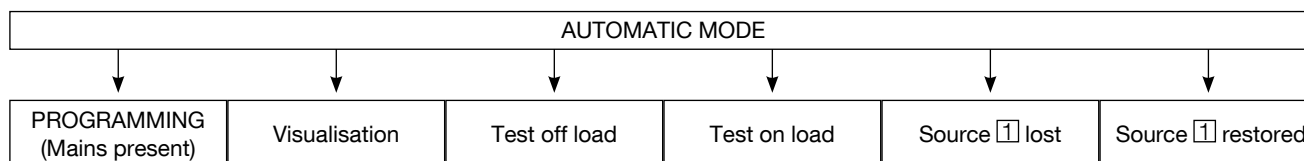

- Automatic mode returns active within 2 seconds after switching from manual to automatic mode.
- Source 1 and source 2 voltage and frequencies are checked to define a stable availability status.

## 12.2. Priority source loss sequence M-G

Stable position in M-G applications

Configuration:

- APP = M-G: Network - Generating set application

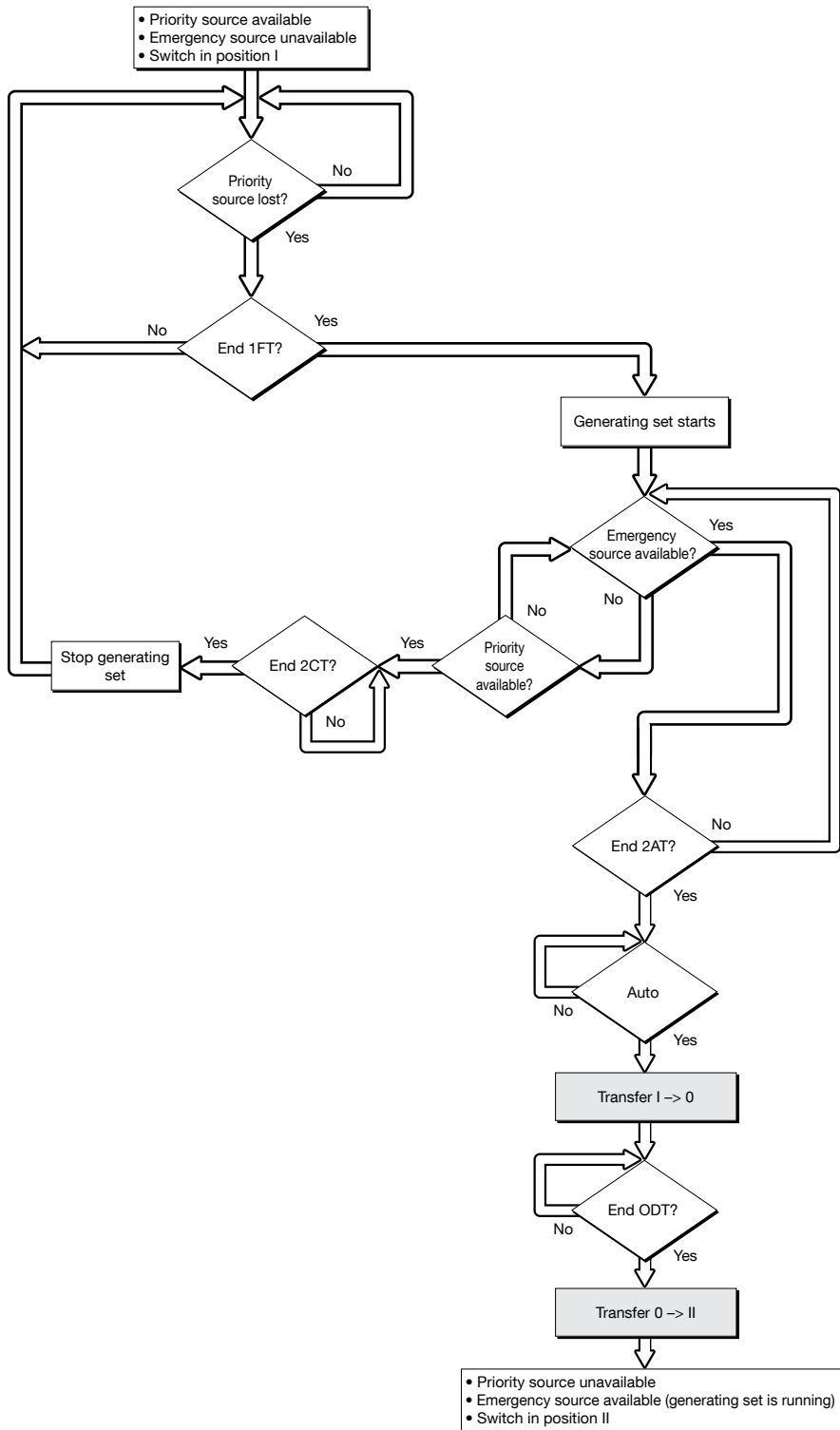

## 12.3. Priority source loss and restoration sequence M-M

Stable position in M-M applications

Configuration

- APP = M-M: Network - Network application

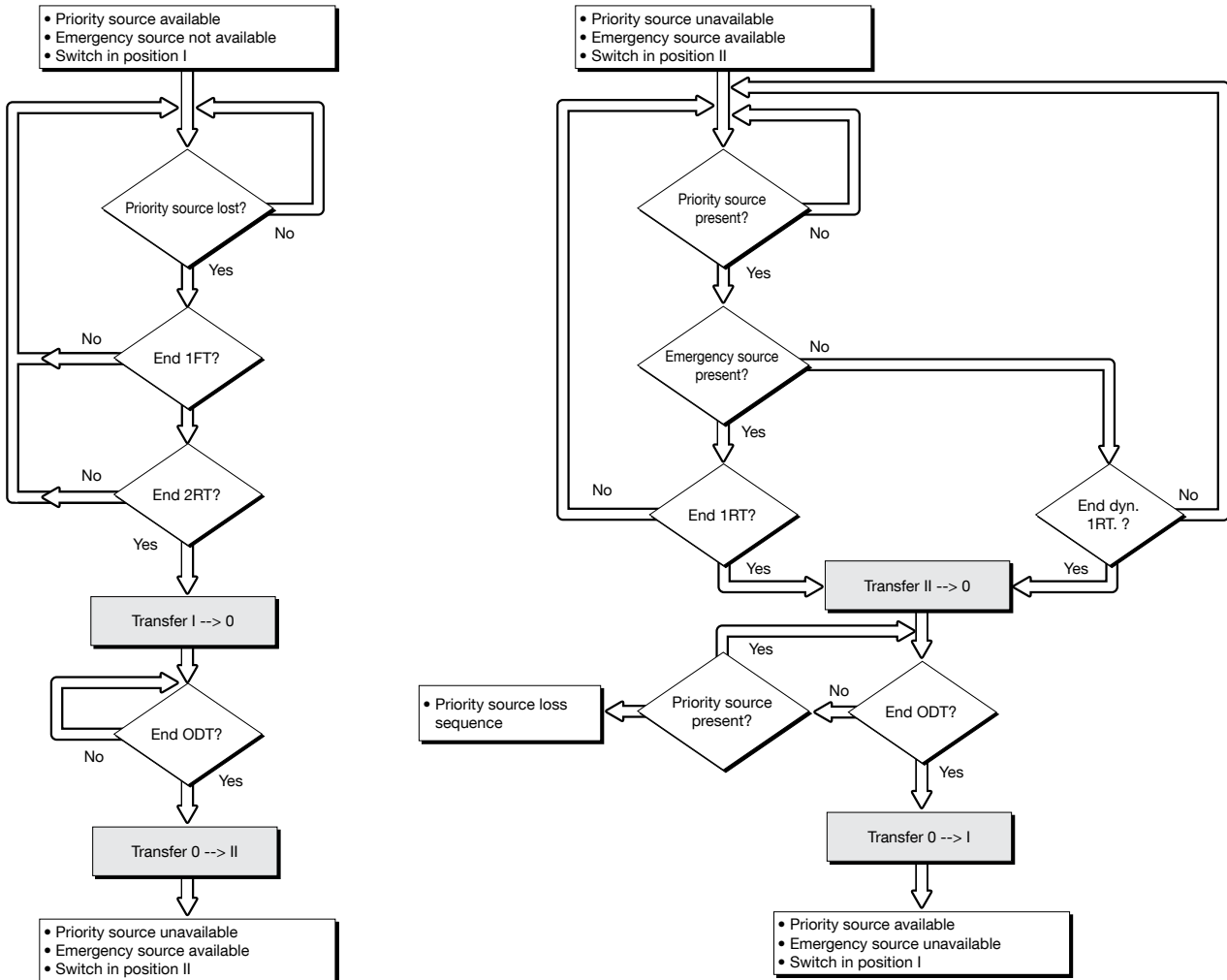

## 12.4. Priority source automatic restoration sequence

This sequence is started as soon as the system is in AUTO mode and in position II. Specific function Automatic retransfer inhibited: Once source 1 is restored, it may be preferable not to retransfer the load from source 2 to source 1 immediately. Once the retransfer from source 2 to source 1 is possible, the RETRANS function locks the retransfer, and the AUT LED flashes pending the operator's confirmation.

The VALIDATION key must be pressed or an input must be programmed on RTC to authorise the retransfer.

## 12.5. Priority source restoration sequence M-G

Stable position in M-G applications

Configuration

- APP = M-G: Network - Generating set application

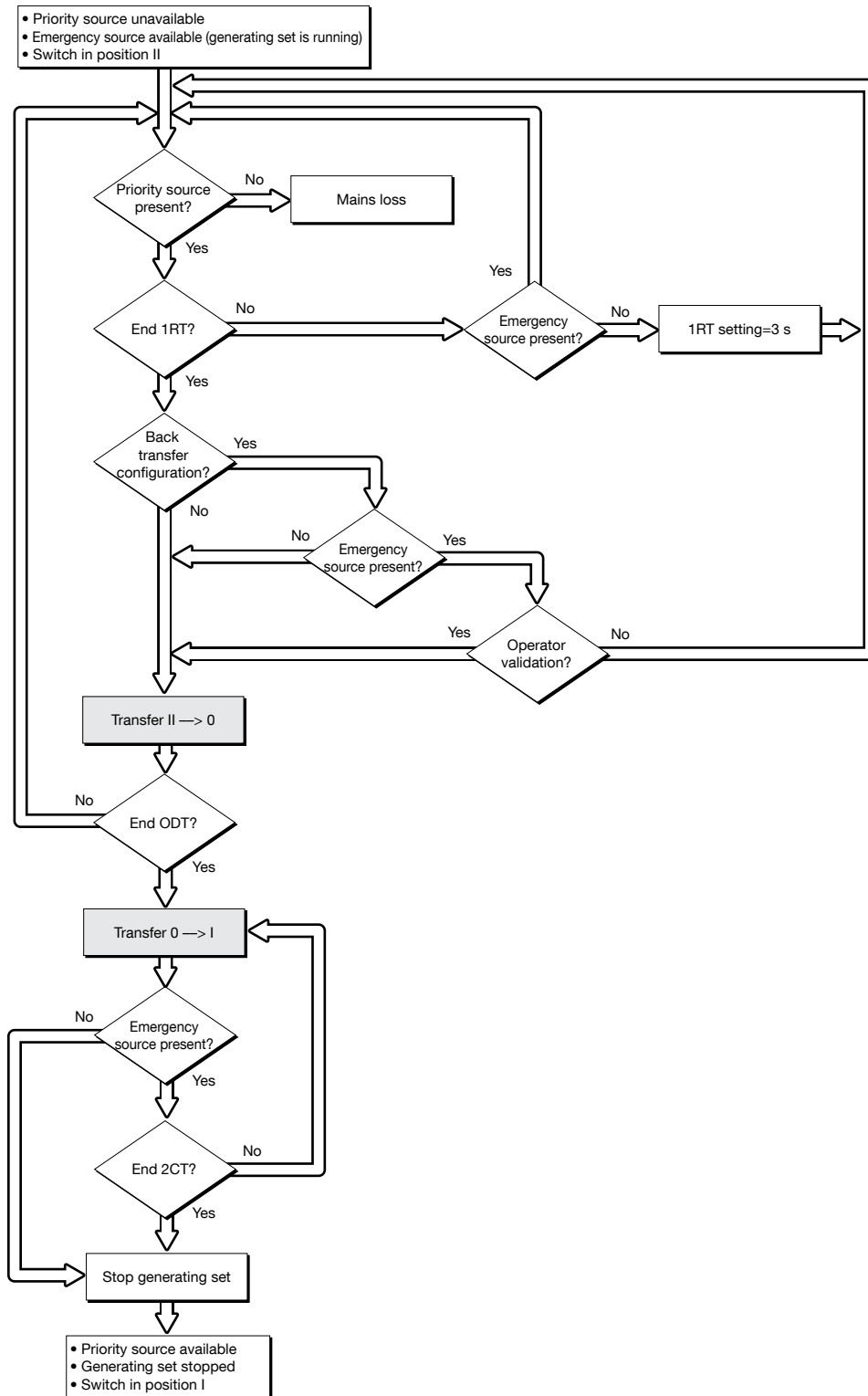

# 13. Test modes

The ATyS p includes for On-Load as well as Off Loads tests that are always associated with Mains – Gen applications. To operate the tests manually through the keypad the following flow diagram shows the different steps.

Tests as well as Engine Exerciser cycles are also easily programmed and triggered when using the ATyS Webserver and the Easy-Config software. Webserver and software will require the Ethernet option installed.

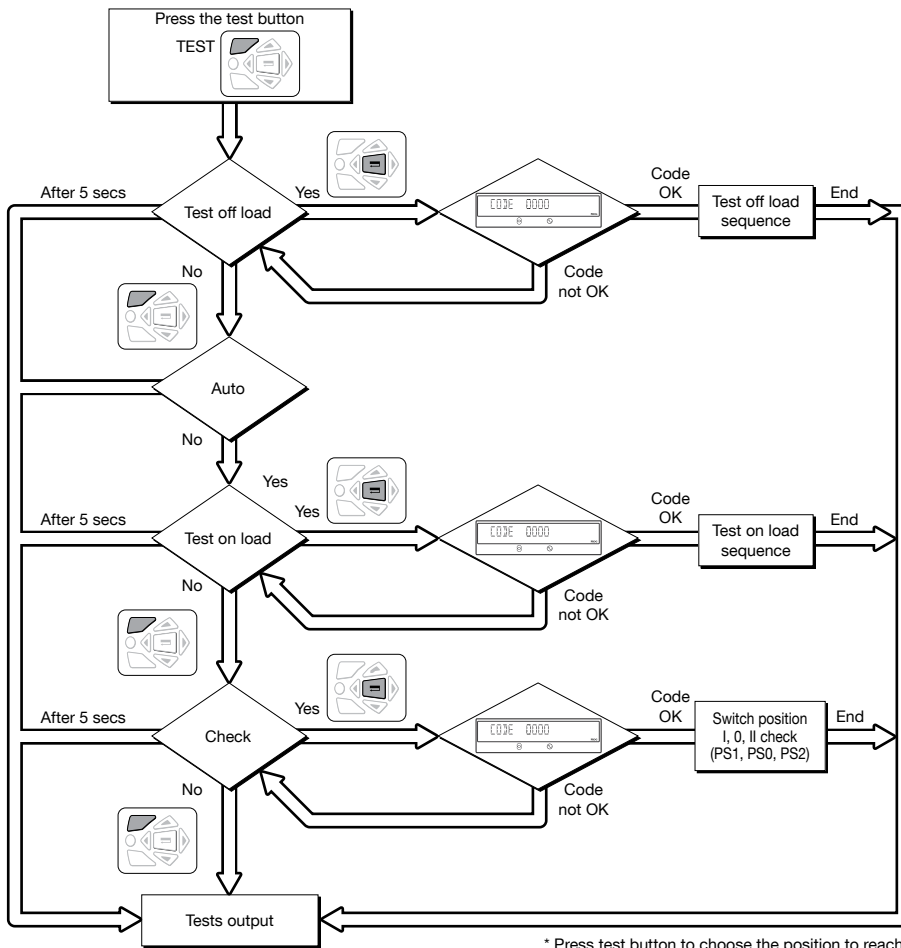

## 13.1. Test Off Load

This test is for Main – Gen applications only and possible to run in automatic as well as manual mode. It can be considered as a manual Genset start order without switching over the load from the main supply to the backup.

### Description:

- This mode enables you to test run the Genset without initiating a load transfer
- The Genset is started and stopped as normal (via the «Gen set start» contact: output 72-71-74).
- This test is always possible to run, except during a main supply (S1) loss sequence. (This is a condition that would stop the test).
- The test duration can be programmed (TFT time delay).

### Activation:

- either on the ATyS p front panel, via the test modes,
- or via the D20 interface,
- or via the programmable input,
- or via communication (Ethernet or MODBUS).



**Deactivation:**

- either by changing the status of the control input
- or by pressing the validation key on the ATyS p or D20 keypad.
- or after a Genset start timeout.
- or at the end of the timer (if set),
- or if the main source supply (S1) is lost,
- or in case of generating set shuts down due to a fault.

## 13.2. Test On Load

This test is for Main – Gen applications and possible to run in automatic mode only. It enables you to start the Genset and simulate a complete transfer sequence, on load.

**Description:**

- The purpose of this sequence is to execute a load transfer from the main supply to the Genset. This is usually done to test the complete cycle, whilst adhering to the changeover conditions.
- The time delays for validating the transfer conditions (TOT, 2ST, 2AT and 2CT) are derived according to their configuration for normal operation.
- The “retransfer confirmation” function is always active throughout an on load test. This enables a retransfer back to the main source supply (S1) in case of an unlimited on load test, or interrupts a time delayed on load test.

**Activation:**

- either on the ATyS p front panel, via the test modes,
- or via the D20 interface,
- or via the programmable input,
- or via communication. (Ethernet or MODBUS).

**Deactivation:**

- either by changing the status of the control input
- or by pressing the validation key on the ATyS p or D20 keypad.
- or after a Genset start timeout.
- or at the end of the timer (if set),
- or in case of generating set shuts down due to a fault.

## 13.3. Engine exerciser (Periodic TEST)

The ATyS p includes a programmable engine exerciser with four independent customizable routines to exercise the engine and Genset. Exercising may be programmed using Easy Config Software or directly through the webserver. It may be carried out with or without loads, on a daily, weekly, bi-weekly monthly or yearly basis. It is also possible to configure non-cyclic exercise runs.

# 14. COMMUNICATION

One can benefit of all the ATyS p functionality when including one of the communication options available.

Options for communication include:

- Ethernet (Modbus TCP) Webserver Gateway Module
- Ethernet (Modbus TCP) Webserver Module
- MODBUS RTU over RS485 Module

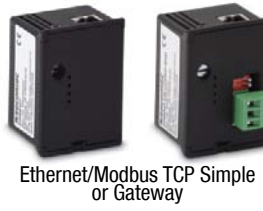

## 14.1. General information

Communication via an RS485 connection (MODBUS® protocol) enables you to connect up to 31 ATyS to a PC or programmable logic controller over a distance of 1200 metres.

To authorise a change in configuration: define adress HEXA E300 as 1000.

### Recommendations:

Use a shielded twisted pair, type LIYCY.

If the distance of 1200 m and / or the number of 31 ATyS be exceeded, it will be necessary to connect a repeater to allow an connection of ATyS for over 1200 m.

For further information on the connection methodology, please consult SOCOMEC.

Communication via an RJ45 Ethernet cable enables you to connect up to 31 ATyS to a PC or a programmable logic controller over a distance of 100 metres. The Ethernet Gateway may accommodate a mix of all Socomec communicating products such as the DIRIS and COUNTIS range of products.

## 14.2. MODBUS® protocol

The MODBUS® protocol used by the ATyS requires a dialogue using a master/slave hierarchical structure. Two dialogues are possible:

- the master communicates with a slave (ATyS) and waits for its response,
- the master communicates with all the slaves (ATyS) without waiting for their response.

The communication mode is RTU (Remote Terminal Unit) which uses hexadecimal 8 bit characters. In the communication protocol, a standard frame is made up of the following elements:



- Slave address: communicating device address
- Function codes:
  - 3: to read n words (maximum 125)
  - 6: to write one word.
  - 16: to write n words (maximum 125).
- Address: Register address (refer to following tables)
- Data: parameters linked to function (number of words, value).  
When slave address 0 is selected, a message is sent to all devices present on the network (only for functions 6 and 16), this type of message is called general distribution, so it is not followed up with a response from the slaves. The maximum response time (timeout) is 250 ms between a question and a response.

**Refer to Annexe III page 81 for communication address and designation details.**

# 15. PUTTING THE ATYS P INTO AUTO OPERATION

After all checks have been verified and all programming and commissioning procedures are ready and ok, once ready to put the ATyS p into AUTO operation, turn the mode selector switch from Manual to Auto.

Note: When the product is powered and properly configured, when switching the product from Manual Mode to AUT the POWER and READY LED's should be a steady Green light.



	<b>WARNING</b>	Depending on the state of the ATyS p the ATS automation may change the switch position as soon as the mode selector is switched to AUT. This is a normal operation.
--	----------------	---

# 16. CHARACTERISTICS

Characteristics according to IEC 60947-3 and IEC 60947-6-1

## 125 to 630 A

Thermal current $I_{th}$ to 40°C	125 A	160 A	200 A	250 A	315 A	400 A	500 A	630 A
Rated insulation voltage $U_i$ (V) (power circuit)	800	800	800	1000	1000	1000	1000	1000
Rated impulse withstand voltage $U_{imp}$ (kV) (power circuit)	8	8	8	12	12	12	12	12
Rated insulation voltage $U_i$ (V) (control circuit)	300	300	300	300	300	300	300	300
Rated impulse withstand voltage $U_{imp}$ (kV) (control circuit)	4	4	4	4	4	4	4	4

Rated operational currents $I_e$ (A) according to IEC 60947-3									
Rated voltage	Utilisation category	A/B	A/B	A/B	A/B	A/B	A/B	A/B	A/B
415 VAC	AC-21 A / AC-21 B	125/125	160/160	200/200	250/250	315/315	400/400	500/500	630/630
415 VAC	AC-22 A / AC-22 B	125/125	160/160	200/200	250/250	315/315	400/400	500/500	630/630
415 VAC	AC-23 A / AC-23 B	125/125	160/160	200/200	200/200	315/315	400/400	500/500	500/630
500 VAC	AC-21 A / AC-21 B	125/125	160/160	200/200	250/250	315/315	400/400	500/500	630/630
500 VAC	AC-22 A / AC-22 B	125/125	160/160	200/200	200/250	200/315	200/400	500/500	500/500
500 VAC	AC-23 A / AC-23 B	80/80	80/80	80/80	200/200	200/200	200/200	400/400	400/400
690 VAC	AC-21 A / AC-21 B	125/125	160/160	200/200	200/200	200/200	200/200	500/500	500/500
690 VAC	AC-22 A / AC-22 B	125/125	125/125	125/125	160/160	160/160	160/160	400/400	400/400
690 VAC	AC-23 A / AC-23 B	63/80	63/80	63/80	125/125	125/125	125/125	400/400	400/400
220 VDC	DC-21 A / DC-21 B	125/125	160/160	200/200	250/250	250/250	250/250	500/500	630/630
220 VDC	DC-22 A / DC-22 B	125/125	160/160	200/200	250/250	250/250	250/250	500/500	630/630
220 VDC	DC-23 A / DC-23 B	125/125	125/125	125/125	200/200	200/200	200/200	500/500	630/630
440 VDC <sup>(1)</sup>	DC-21 A / DC-21 B	125/125	125/125	125/125	200/200	200/200	200/200	500/500	630/630
440 VDC <sup>(1)</sup>	DC-22 A / DC-22 B	125/125	125/125	125/125	200/200	200/200	200/200	500/500	630/630
440 VDC <sup>(1)</sup>	DC-23 A / DC-23 B	125/125	125/125	125/125	200/200	200/200	200/200	500/500	630/630

Rated operational currents $I_e$ (A) according to IEC 60947-6-1									
Rated voltage	Utilisation category								
415 VAC	AC-31 B	125	160	200	250	315	400	500	630
415 VAC	AC-32 B				200	315	400	500	500
415 VAC	AC-33 B				200	200	200	400	400

Current rated as conditional short-circuit with fuse gG DIN, according to IEC 60947-3									
Prospective fuse protected short-circuit withstand at 415 VAC(6)	100	100	50	50	50	50	50	50	50
Prospective fuse protected short-circuit withstand at 690 VAC(kA rms)	/	/	/	50	50	50	50	50	50
Associated fuse rating (A)	125	160	200	250	315	400	500	630	

Current rated as conditional short-circuit according to IEC 60947-3									
Current rated as short-time withstand $I_{cw}$ 0,3s, 415 VAC (kA rms)	12	12	12	15	15	15	17	17	
Current rated as short-time withstand $I_{cw}$ 0,3s, 690 VAC (kA rms)	/	/	/	15	15	15	17	17	
Current rated as short-time withstand $I_{cw}$ 1s, 415 VAC (kA rms)	7	7	7	8	8	8	10	10	
Current rated as short-time withstand $I_{cw}$ 1s, 690 VAC (kA rms)	/	/	/	8	8	8	10	10	
Power rated as closing short-circuit $I_{cm}$ at 415 VAC (peak kA)	11.9	11.9	11.9	22	22	22	17	17	

Current rated as conditional short-circuit according to IEC 60947-6-1									
Current rated as short-time withstand $I_{cw}$ 30 ms (kA rms), 415 VAC	10	10	10	10	10	10	/	/	
Current rated as short-time withstand $I_{cw}$ 60 ms (kA rms), 415 VAC	/	/	/	/	/	/	10	12.6	
Power rated as closing short-circuit $I_{cm}$ at 415 VAC (peak kA)	17	17	17	17	17	17	17	25	

Connection									
Minimum Cu cable cross-section as per IEC 60947-1 (mm <sup>2</sup> )	35	35	50	95	120	185	2 x 95	2 x 120	
Recommended Cu busbar cross-section (mm <sup>2</sup> )							2 x 32 x 5	2 x 40 x 5	
Maximum Cu cable cross-section (mm <sup>2</sup> )	50	95	120	150	240	240	2 x 185	2 x 300	
Maximum Cu busbar width (mm)	25	25	25	32	32	32	50	50	
Min./max. tightening torque (Nm)	9/13	9/13	9/13	20/26	20/26	20/26	40/45	40/45	

Switching time (rated voltage, after receiving command)									
Time of transfer I-II or II-I (s)	0.85	0.85	0.85	0.9	0.9	0.9	0.95	0.95	
I-0 or II-0 (s)	0.55	0.55	0.55	0.5	0.5	0.5	0.55	0.55	
Time of contact transfer ("black-out" I-II) minimum (s)	0.3	0.3	0.3	0.4	0.4	0.4	0.4	0.4	

Power supply									
Min./max. power (VAC)	166/332	166/332	166/332	166/332	166/332	166/332	166/332	166/332	166/332

Control supply power demand									
Demand/rated power (VA) - ATyS r, ATyS d	184/92	184/92	184/92	276/115	276/115	276/115	276/150	276/150	
Demand/rated power (VA) - ATyS t, g, p	206/114	206/114	206/114	298/137	298/137	298/137	298/172	298/172	

Mechanical specifications									
Durability (number of operating cycles)	10,000	10,000	10,000	8,000	8,000	8,000	5,000	5,000	
Weight ATyS r 3 P / 4 P (kg)	5.7/ 6.9	5.7/ 6.9	5.7/ 6.9	6.6/ 7.4	6.7/ 7.8	6.7/ 7.8	11.4/ 13.3	11.9/ 14.0	
Weight ATyS d 3 P / 4 P (kg)	6.3/ 7.5	6.3/ 7.5	6.3/ 7.5	7.2/ 8.0	7.3/ 8.4	7.3/ 8.4	12.0/ 13.9	12.5/ 14.6	
Weight ATyS t, g, p 3 P / 4 P (kg)	6.8/ 8.0	6.8/ 8.0	6.8/ 8.0	7.7/ 8.5	7.8/ 8.9	7.8/ 8.9	12.5/ 14.4	13.0/ 15.1	

(1) 3-pole device with 2 „+“ poles in series and 1 „-“ pole. 4-pole device with 2 poles in series by polarity

## 800 to 3200 A

Thermal current $I_{th}$ at 40°C	800 A	1000 A	1250 A	1600 A	2000 A	2500 A	3200 A
Rated insulation voltage $U_i$ (V) (power circuit)	1000	1000	1000	1000	1000	1000	1000
Rated impulse withstand voltage $U_{imp}$ (kV) (power circuit)	12	12	12	12	12	12	12
Rated insulation voltage $U_i$ (V) (control circuit)	300	300	300	300	300	300	300
Rated impulse withstand voltage $U_{imp}$ (kV) (control circuit)	4	4	4	4	4	4	4

### Rated operational currents $I_e$ (A) according to IEC 60947-3

Rated voltage	Utilisation category	A/B	A/B	A/B	A/B	A/B	A/B	A/B
415 VAC	AC-21 A / AC-21 B	800/800	1000/1000	1250/1250	1600/1600	-/2000	-/2500	-/3200
415 VAC	AC-22 A / AC-22 B	800/800	1000/1000	1250/1250	1600/1600	-/2000	-/2500	-/3200
415 VAC	AC-23 A / AC-23 B	800/800	1000/1000	1250/1250	1250/1250	-/1600	-/1600	-/1600
500 VAC	AC-21 A / AC-21 B	800/800	1000/1000	1250/1250	1600/1600	-/2000	-/2000	-/2000
500 VAC	AC-22 A / AC-22 B	630/630	800/800	1000/1000	1600/1600			
500 VAC	AC-23 A / AC-23 B	630/630	630/630	800/800	1000/1000			
690 VAC	AC-21 A / AC-21 B	800/800	1000/1000	1250/1250	1600/1600	-/2000	-/2000	-/2000
690 VAC	AC-22 A / AC-22 B	630/630	800/800	1000/1000	1000/1000			
690 VAC	AC-23 A / AC-23 B	400/400	630/630	800/800	800/800			
220 VDC	DC-21 A / DC-21 B	800/800	1000/1000	1250/1250	1250/1250			
220 VDC	DC-22 A / DC-22 B	800/800	1000/1000	1250/1250	1250/1250			
220 VDC	DC-23 A / DC-23 B	800/800	1000/1000	1250/1250	1250/1250			
440 VDC <sup>(1)</sup>	DC-21 A / DC-21 B	800/800	1000/1000	1250/1250	1250/1250			
440 VDC <sup>(1)</sup>	DC-22 A / DC-22 B	800/800	1000/1000	1250/1250	1250/1250			
440 VDC <sup>(1)</sup>	DC-23 A / DC-23 B	800/800	1000/1000	1250/1250	1250/1250			

### Rated operational currents $I_e$ (A) according to IEC 60947-6-1

Rated voltage	Utilisation category	800	1000	1250	1600	2000	2500	3200
415 VAC	AC-31 B	800	1000	1250	1600	2000	2500	3200
415 VAC	AC-32 B	800	1000	1250	1250	2000	2000	2000
415 VAC	AC-33 B	800	1000	800	1000	1250	1250	1250

### Current rated as conditional short-circuit with fuse gG DIN, according to IEC 60947-3

Prospective fuse protected short-circuit withstand at 415 VAC (kA rms)	50	50	100	100	/	/	/
Prospective fuse protected short-circuit withstand at 690 VAC (kA rms)	50	50	50	/	/	/	/
Associated fuse rating (A)	800	1000	1250	2x800			

### Current rated as conditional short-circuit according to IEC 60947-3

Current rated as short-time withstand $I_{ow}$ 0,3s, 415 VAC (kA rms)	64	64	64	78	78	78	78
Current rated as short-time withstand $I_{ow}$ 0,3s, 690 VAC (kA rms)	/	/	/	/	/	/	/
Current rated as short-time withstand $I_{ow}$ 1s, 415 VAC (kA rms)	35	35	35	50	50	50	50
Current rated as short-time withstand $I_{ow}$ 1s, 690 VAC (kA rms)	/	/	/	/	/	/	/
Power rated as closing short-circuit $I_{cm}$ at 415 VAC (peak kA)	73,5	73,5	73,5	105	105	105	105

### Current rated as conditional short-circuit according to IEC 60947-6-1

Current rated as short-time withstand $I_{ow}$ 30 ms (kA rms), 415 VAC	/	/	/	/	/	/	/
Current rated as short-time withstand $I_{ow}$ 60 ms (kA rms), 415 VAC	20	20	25	32	50	50	50
Power rated as closing short-circuit $I_{cm}$ at 415 VAC (peak kA)	40	40	52.5	67.2	105	105	105

### Connection

Minimum Cu cable cross-section as per IEC 60947-1 (mm <sup>2</sup> )	2 x 185						
Recommended Cu busbar cross-section (mm <sup>2</sup> )	2 x 50 x 5	2 x 63 x 5	2 x 60 x 7	2 x 100 x 5	3 x 100 x 5	2 x 100 x 10	3 x 100 x 10
Maximum Cu cable cross-section (mm <sup>2</sup> )	2 x 300	4 x 185	4 x 185	6 x 185			
Maximum Cu busbar width (mm)	63	63	63	100	100	100	100
Min./max. tightening torque (Nm)	9/13	9/13	20/26	40/45	40/45	40/45	40/45

### Switching time (rated voltage, after receiving command)

Time of transfer I-II or II-I (s)	2.8	2.8	2.8	2.9	2.8	2.8	2.8
I-0 or II-0 (s)	1.4	1.4	1.4	1.4	1.8	1.8	1.8
Time of contact transfer ("black-out" I-II) minimum (s)	1.4	1.4	1.4	1.5	1	1	1

### Power supply

Min./max. power (VAC)	166/332	166/332	166/332	166/332	166/332	166/332	166/332
-----------------------	---------	---------	---------	---------	---------	---------	---------

### Control supply power demand

Demand/rated power (VA) - ATyS r, ATyS d	460/184	460/184	460/184	460/230	812/322	812/322	812/322
Demand/rated power (VA) - ATyS t, g, p	482/206	482/206	482/206	482/252	834/344	834/344	834/344

### Mechanical specifications

Durability (number of operating cycles)	4,000	4,000	4,000	3,000	3,000	3,000	3,000
Weight ATyS r 3 P / 4 P (kg)	27.9/ 32.2	28.4/ 32.9	28.9/ 33.6	33.1/ 39.4	50.7/ 61.6	50.7/ 61.6	61.0/ 75.3
Weight ATyS d 3 P / 4 P (kg)	28.5/ 32.8	29.0/ 33.5	29.5/ 34.2	33.7/ 40.0	51.3/ 62.2	51.3/ 62.2	61.6/ 75.9
Weight ATyS t, g, p 3 P / 4 P (kg)	29.0/ 33.3	29.5/ 34.0	30.0/ 34.7	34.2/ 40.5	51.8/ 62.7	51.8/ 62.7	62.1/ 76.4

(1) 3-pole device with 2 „+“ poles in series and 1 „-“ pole. 4-pole device with 2 poles in series by polarity

## 17. PREVENTIVE MAINTENANCE

It is recommended to verify the tightening torque of all connections and to operate the product in a full operating cycle (I – 0 – II – 0 – I: Auto and Manual) at least once a year.

Note: Maintenance should be planned carefully and carried out by qualified and authorised personnel. Consideration of the critical level and application where the product is installed should form an essential and integral part of the maintenance plan. Good engineering practice is imperative whilst all necessary precautions must be taken to ensure that the intervention (whether directly or indirectly) remains safe in all aspects.

## 18. TROUBLE SHOOTING GUIDE

<p>The ATyS p does not operate electrically</p>	<ul style="list-style-type: none"> <li>• Verify the power supply on terminals 101-102 and 201-202: 208 - 277 VAC <math>\pm 20\%</math></li> <li>• Verify that the front selector switch is in position (AUT)</li> <li>• Verify that contacts 313 and 317 are open.</li> <li>• Verify that the power LED (Green) is On whilst the fault LED (RED) is off.</li> <li>• Verify that the Ready light on the ATS controller is a steady Green light.</li> <li>• Verify presence of at least one green LED on the source supply available LED's.</li> <li>• Verify that the product is available with contacts 63A / 64A and 63B / 64B closed.</li> <li>• Verify whether the problem is limited to the ATS controller or the motorisation module or both.</li> </ul> <p><b>Note:</b> To isolate the fault to the ATS controller or the complete unit, close contacts 312 with 317 whilst ensuring that 313 and 317 remain open. This will force the ATyS p into remote control which will bypass the ATS controller and accept position orders from contacts 314 to 317.</p>
<p>It is not possible to manually operate the switch</p>	<ul style="list-style-type: none"> <li>• Verify that the front selector switch position is on the Manual position.</li> <li>• Make sure that the product is not padlocked</li> <li>• Verify the rotation direction of the handle</li> <li>• Apply a sufficient progressive action in the direction as indicated on the handle</li> </ul>
<p>Electrical operation does not correspond to external order I,0,II</p>	<ul style="list-style-type: none"> <li>• Verify the selected control logic wiring (impulse or contactor)</li> <li>• Verify the connector connections.</li> </ul>
<p>Impossible to padlock</p>	<ul style="list-style-type: none"> <li>• Verify that the front selector switch is in manual position</li> <li>• Verify that the emergency handle for manual operation is not inserted into the ATyS manual slot.</li> <li>• Verify that the ATyS is in 0 position (Padlocking is only possible in 0 position for standard products)</li> </ul>
<p>The AUT light is flashing</p>	<ul style="list-style-type: none"> <li>• The AUT LED will be steady green when in AUTO Mode and will be flashing green when the ATyS p has timers running.</li> <li>• This is usually a normal indication.</li> </ul>
<p>The fault LED is ON (Motorisation module)</p>	<ul style="list-style-type: none"> <li>• The FAULT / MANUAL LED on the motorisation module is on when in manual mode (this is normal) and in AUT Mode when there is an internal fault in the ATyS p. To reset a fault condition switch the ATyS p from AUT to Manu and back to AUT. Should the fault LED remain on you will need to localize and clear the fault prior to reset.</li> <li>• The FAULT / Manual LED will also be on when contact 313 is closed with 317. (Force the ATyS to off position). This is a normal condition.</li> <li>• Should the Fault LED remain on abnormally, contact SOCOMECE.</li> </ul>

The fault LED is on (ATS Controller)	<ul style="list-style-type: none"> <li>• Switch the ATyS p from AUT to Manual and back to AUT. Should the fault condition remain contact SOCOMEC)</li> </ul> <p><b>Note:</b> In case the external fault / alarm condition is active through one of the ATyS configurable inputs, the fault LED on the ATS controller will be on. This is a normal condition and resettable by opening the associated contact input.</p>
The SOURCE availability indicator does not illuminate when the source is available.	<ul style="list-style-type: none"> <li>• Press the "LED test" button and ensure that the corresponding LED's illuminate.</li> <li>• Check in programming mode that the nominal voltage value (by default set to 400V), the nominal frequency value and the network configuration correspond to the network and modify if necessary.</li> <li>• Check the voltage and frequency thresholds and hysteresis for this source, in the Volt and Frequency menus and modify if necessary.</li> </ul>
The product displays the message: F13 ROT-1 or F23 ROT-2	<ul style="list-style-type: none"> <li>• Check for phase rotation consistency (or conventional direction) between the source and parameter ROT in the SETUP menu, or between the two sources.</li> </ul>
Nothing happens following a loss of the priority source (application Main-Gen)	<ul style="list-style-type: none"> <li>• Check the setting of 1FT. After 1FT has counted down 71-72-74 should change state.</li> <li>• Check the status of the "gen set start" contact (contact 71-73-74) after 1FT countdown.</li> <li>• Check the wiring from the "gen set start" contact (71-72-74) to the generating set controller.</li> </ul>
The product does not switch over after the priority source is lost.	<ul style="list-style-type: none"> <li>• Check back-up source availability.</li> <li>• Check back-up source voltage and frequency thresholds and hystereses and modify if required.</li> <li>• Check that the product selector switch is in AUTO.</li> <li>• Check that automatic operation has not been inhibited by external orders.</li> <li>• Check priority source voltage and frequency thresholds and hystereses and modify if necessary.</li> <li>• Check that the time-delay 1RT (Source 1 Return Timer) has counted down, and that it is not too long. (The display indicates 1RT xxxSEC).</li> <li>• Check in programming mode that the "manual retransfer" function is not activated. If this function is unnecessary: In the SETUP menu, the RETRANS variable must be at NO.</li> <li>• Check that automatic operation has not been inhibited by external orders.</li> <li>• Check that the INH input is not activated.</li> </ul>
Return to priority source 1 has been executed, but source 2 is still running (M-G application)	<ul style="list-style-type: none"> <li>• Check that CDT (Cool Down Timer) has counted down. The display indicates CDT xxx SEC after switchover to the priority source.</li> <li>• Check the status of the "gen set start" contact (contact 71 – 72 - 74) Check that the contact changes state after timedelay CDT has counted down.</li> <li>• Check that the product is not in MAN, CONTROL or INH mode. In this case Manual or Control LMED would be On.</li> </ul>
The ON LOAD and OFF LOAD tests cannot be started via the keypad	<ul style="list-style-type: none"> <li>• Check that the mode selector switch is set to AUT and that the AUT LED is illuminated.</li> </ul> <p><b>Note:</b> In Manual mode, only the OFF LOAD TEST can run.</p> <ul style="list-style-type: none"> <li>• Check the operating mode password (factory code 0000) to access the test functions.</li> <li>• Check that the ON LOAD TEST or OFF LOAD TEST LEDs are illuminated, according to the selected test mode.</li> <li>• Check that the product is set to application type M-G.</li> <li>• Check that there is no mains loss when starting the test. The SOURCE LED (priority side) should be illuminated.</li> <li>• Check the status of the "gen set start" contact (contact 71-72-74).</li> </ul>
Product displays an event or error message	<ul style="list-style-type: none"> <li>• Refer to chapter Events list and Error messages list in this manual.</li> </ul>

## 18.1. Events display

Typical example for decoding an events message on the LCD Screen.

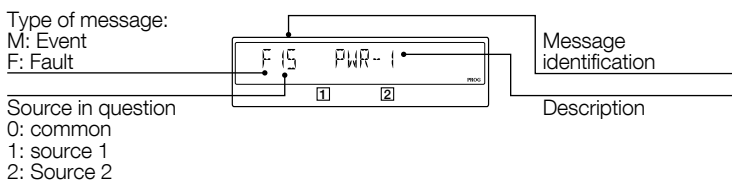

MESSAGE	DEFINITION	ACTION	RESET
FAIL START	If the generating set does not start after the 2ST delay, the message will be sent.	Check the generating set.	Press the validation key
RETRANSFER?	Retransfer confirmation	Press the validation key if OK to Retransfer	Automatic
STOP TON?	Test off load end confirmation	Press the validation key if OK to end the TON	Automatic
F00 OPFACTOR	Duty Cycle Fault Limited number of operations in a defined period.	Wait 1 min. for the error message to disappear.	Automatic
F03 NEUTRAL	Neutral Fault: The neutral on source 1 is not wired on the same side as the neutral on source 2 .	Check and rewire one of the two sources.	Change the selector switch from AUT to Manual and back to AUT
F11 FLT 1	Ext fault S1 with 0 return: This fault only appears if input FT1/FT2 (see I-O Menu). Activation of this fault shifts the changeover switch to position 0.	Resolve the external problem that caused activation of input FT1/FT2	Change the selector switch from AUT to Manual and back to AUT
F12 ALR 1	Ext fault S1 without 0 return: This fault only appears if input AL1/AL2 is activated (see I-O Menu).	Resolve the external problem. Once this is done, the error message will disappear.	Automatic
F13 ROT 1	Phase rotation fault on source 1 The phase rotation does not correspond to the ROT PH. Variable in the Setup menu.	Invert two phases on source 1 / source 2	Automatic
F16 POS 1	Position I not reached: Fault position following an electric or automatic order, position I is not reached.	Provisional action: Switch to manual mode and operate manually.	Change source status. Manual operation.
F21 FLT 2	Ext fault S2 with 0 return: This fault only appears if input FT2 (see I-O Menu). Activation of this fault shifts the changeover switch to position 0.	Resolve the external problem that caused activation of input FT2	Change the selector switch from AUT to Manual and back to AUT
F22 ALR 2	Ext fault S2 without 0 return: This fault only appears if input AL2 is activated (see I-O Menu).	Resolve the external problem. Once this is done, the error message will disappear.	Automatic
F23 ROT2	Phase rotation fault on source 2 The phase rotation does not correspond to the ROT PH. Variable in the Setup menu.	Invert two phases on source 1 / source 2	Automatic
F26 POS 2	Position 0 not reached: Fault position following an electric or automatic order, position 0 is not reached	Switch to manual mode and operate manually.	Change source status. Manual operation.
F06 POS 0	Position 0 not reached: Fault position following an electric or automatic order, position 0 is not reached.	Switch to manual mode and operate manually.	Change source status. Manual operation.
F08 MAIN FLT	Main fault	Contact your nearest dealer	
F09 MOT FLT	Motor fault	Contact your nearest dealer	
ATS VER 100	Product version	Informative	Automatic
F17 UNB 1	Source 1 unbalanced	Check the sensing voltages. Enter the values through the Voltage Levels Menu	Change the selector switch from AUT to Manual and back to AUT
F27 UNB 2	Source 2 unbalanced	Check the sensing voltages. Enter the values through the Voltage Levels Menu	Change the selector switch from AUT to Manual and back to AUT
F07 AUTOCONF	Auto - Configuration failed	Check the sensing voltages. Enter the values through the Voltage Levels Menu.	Change the selector switch from AUT to Manual and back to AUT
SAVED	User backup settings saved / settings saved	No Action	Automatic
LOADED	User backup settings loaded	No Action	Automatic



# 19. ACCESSORIES

## 19.1. Terminal shrouds

### Use

IP2X protection against direct contact with terminals or connecting parts.

### Advantages

Perforations allow remote thermographic inspection without the need to remove the shrouds.

Rating (A)	Frame size	No. of poles	Position	Reference
125 ... 200	B3	3 P	top / bottom / front (I) / rear (II)	2694 <b>3014</b> <sup>(1)(2)</sup>
125 ... 200	B3	4 P	top / bottom / front (I) / rear (II)	2694 <b>4014</b> <sup>(1)(2)</sup>
250 ... 400	B4	3 P	top / bottom / front (I) / rear (II)	2694 <b>3021</b> <sup>(1)(2)</sup>
250 ... 400	B4	4 P	top / bottom / front (I) / rear (II)	2694 <b>4021</b> <sup>(1)(2)</sup>
500 ... 630	B5	3 P	top / bottom / front (I) / rear (II)	2694 <b>3051</b> <sup>(1)(2)</sup>
500 ... 630	B5	4 P	top / bottom / front (I) / rear (II)	2694 <b>4051</b> <sup>(1)(2)</sup>

(1) To shroud front switch top and bottom 2 references required.

(2) To fully shroud front, rear, top and bottom 4 references required.



access\_206\_a\_2\_cat

## 19.2. Terminal screens

### Use

Top and bottom protection against direct contact with terminals or connection parts.

For upstream and downstream protection, order the reference once.

Rating (A)	Frame size	No. of poles	Position	Reference
125 ... 200	B3	3 P	top / bottom	1509 <b>3012</b>
125 ... 200	B3	4 P	top / bottom	1509 <b>4012</b>
250 ... 400	B4	3 P	top / bottom	1509 <b>3025</b>
250 ... 400	B4	4 P	top / bottom	1509 <b>4025</b>
500 ... 630	B5	3 P	top / bottom	1509 <b>3063</b>
500 ... 630	B5	4 P	top / bottom	1509 <b>4063</b>
800 ... 1250	B6	3 P	top / bottom	1509 <b>3080</b>
800 ... 1250	B6	4 P	top / bottom	1509 <b>4080</b>
1600	B7	3 P	top / bottom	1509 <b>3160</b>
1600	B7	4 P	top / bottom	1509 <b>4160</b>
2000 ... 3200	B8	3 P	top / bottom	1509 <b>3200</b>
2000 ... 3200	B8	4 P	top / bottom	1509 <b>4200</b>



access\_207\_a\_2\_cat

## 19.3. Bridging bars

### Use

For bridging power terminals on the top or bottom side of the switch. One piece required per pole.

Rating (A)	Frame size	No. of poles	Section (mm)	Reference
125 ... 200	B3	3 P	20 x 2.5	4109 <b>3019</b>
125 ... 200	B3	4 P	20 x 2.5	4109 <b>4019</b>
250	B4	3 P	25 x 2.5	4109 <b>3025</b>
250	B4	4 P	25 x 2.5	4109 <b>4025</b>
315 ... 400	B4	3 P	32 x 5	4109 <b>3039</b>
315 ... 400	B4	4 P	32 x 5	4109 <b>4039</b>
500	B5	3 P	32 x 5	4109 <b>3050</b>
500	B5	4 P	32 x 5	4109 <b>4050</b>
630	B5	3 P	50 x 5	4109 <b>3063</b>
630	B5	4 P	50 x 5	4109 <b>4063</b>
800 ... 1000	B6	3 P	50 x 6	4109 <b>3080</b>
800 ... 1000	B6	4 P	50 x 6	4109 <b>4080</b>
1250	B6	3 P	60 x 8	4109 <b>3120</b>
1250	B6	4 P	60 x 8	4109 <b>4120</b>
1600	B7	3 P	90 x 10	4109 <b>3160</b>
1600	B7	4 P	90 x 10	4109 <b>4160</b>

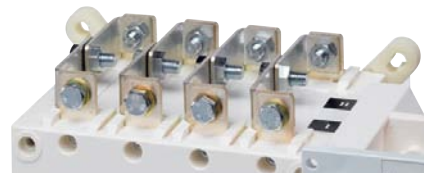

access\_205\_a\_2\_cat

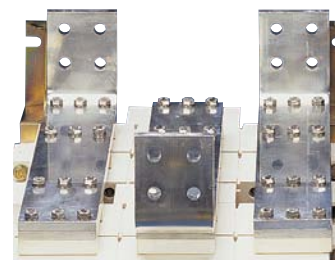

access\_041\_a\_1\_cat

## 19.4. Copper bar connection kits

### Use

Enables:

- connection between the two power terminals of the same pole for 2000 to 3200 A ratings (Fig. 1 and Fig 2)
- up or downstream bridging connection (Fig. 3).

For 3200 A rating, the connection pieces (part A) are delivered bridged from factory. Bolt sets must be ordered separately.

Further details for these specific accessories are available in the user guide downloadable from [www.socomec.com](http://www.socomec.com).

The numbers given in the table below refer to the contact connection.

	Part number	2000 – 2500 A			3200 A		
		Fig. 1	Fig. 2	Fig. 3	Fig. 1	Fig. 2	Fig. 3
		Connection		Outage bridge I and II	Connection		Outage bridge I and II
Flat	Onsite	Flat	Onsite				
Connection part A	2619 1200	1	1	2 <sup>(2)</sup>	included	included	included
Screw kit 35 mm part B	2699 1201	1 <sup>(1)</sup>		2 <sup>(2)</sup>	1 <sup>(1)</sup>		2 <sup>(2)</sup>
Screw kit 45 mm part B	2699 1200	1 <sup>(1)</sup>			1 <sup>(1)</sup>		
T + screw kit part C	2629 1200		1	1		1	1
Bracket + screw kit part D	2639 1200		1			1	
Bar + screw kit part E	4109 0320			1			1

Then multiply the quantity by the number of contacts you need.

<sup>(1)</sup> Choose the right length according to the width of the bars in place. If more than 20 mm, use 45 mm screws.

<sup>(2)</sup> For the bridging setup you need 2 parts for each pole as the contacts of units I and II are connected.

For example, for a 4 P 2500 A with onsite upstream connection (Fig. 2) and downstream bridging (Fig. 3), please order

16 x 2619 1200    12 x 2629 1200  
 8 x 2699 1201    4 x 4109 0320  
 8 x 2639 1200

Fig. 1

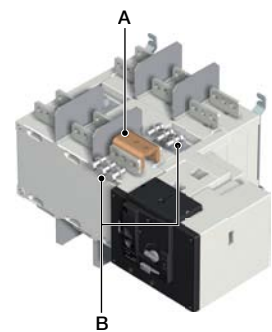

access\_459\_a\_1\_x\_cat

Fig. 2

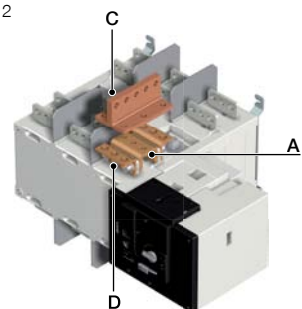

access\_460\_a\_1\_x\_cat

Fig. 3

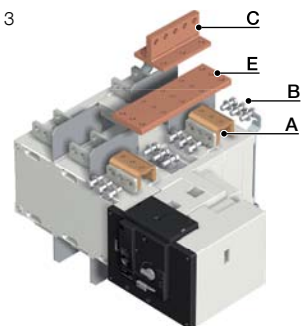

access\_461\_a\_1\_x\_cat

## 19.5. Solid neutral

### Use

The connection kit enables the connection between the input and output neutrals, without any need to switch the neutral.

Rating (A)	Frame size	Reference
125 ... 200	B3	9509 0012
200 ... 315	B4	9509 0025
400	B4	9509 0040
500 ... 630	B5	9509 0063
800 ... 1000	B6	9509 0080
1250	B6	9509 0120
1600	B7	9509 0160

## 19.6. Autotransformer 400/230 VAC

### Use

For applications without neutral, this autotransformer provides the 230 VAC required to power these ATyS products.

Rating (A)	Frame size	Reference
125 ... 3200	B3 ... B8	1599 4064

## 19.7. DC power supply

### Use

Allows an ATyS to be supplied from a 12, 24 or 48 VDC source.  
To be positioned as close as possible to the DC power supply source.

Rating (A)	Frame size	Operating voltage	Reference
125 ... 3200	B3 ... B8	12 VDC / 230 VAC	1599 5012
125 ... 3200	B3 ... B8	24 VDC / 230 VAC	1599 5112
125 ... 1600	B3 ... B7	48 VDC / 230 VAC	1599 5212

## 19.8. Voltage sensing and power supply kit

### Use

For power supply and voltage measurement (4 wire, three-phase) for the ATyS t, g and p.

Routing of the conductors is controlled, which means that no specific protective device is necessary for these connections.

The kit can be fitted on the top or bottom of the switch.

**Note: the 3-pole version does not integrate the power supply.**

From 125 to 630 A

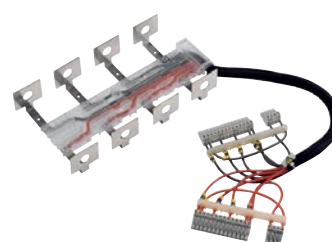

atys\_600\_a\_1\_cat

From 800 to 3200 A

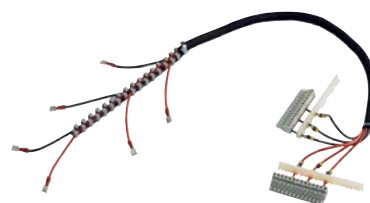

atys\_603\_a\_2\_cat

### For ATyS t, g and p - 3 poles

Rating (A)	Frame size	Reference
125 ... 200	B3	1559 3012
250	B4	1559 3025
315 ... 400	B4	1559 3040
500 ... 630	B5	1559 3063
800 ... 1000	B6	1559 3080
1250	B6	1559 3120
1600	B7	1559 3160
2000 ... 3200	B8	1559 3200

### For ATyS t, g and p - 4 poles

Rating (A)	Frame size	Reference
125 ... 200	B3	1559 4012
250	B4	1559 4025
315 ... 400	B4	1559 4040
500 ... 630	B5	1559 4063
800 ... 1000	B6	1559 4080
1250	B6	1559 4120
1600	B7	1559 4160
2000 ... 3200	B8	1559 4200

## 19.9. Voltage relay

### Use

The ATyS DS is a voltage relay for monitoring a three-phase power supply source.

The fault relay will close as soon as a fault is detected on the supply being monitored.

Rating (A)	Reference
DS	192X 0056



atys\_762\_a\_1\_cat

## 19.10. Door protective surround

### Use

When direct access to the ATyS front face (mode selection, manual operation, display...) is required, the door surround can be utilised to provide a clean and safe finish to the panel's cut-out.

### For ATyS r

Rating (A)	Frame size	Reference
125 ... 630	B3 ... B5	1529 0012
800 ... 3200	B6 ... B8	1529 0080

### For ATyS d, t, g and p

Rating (A)	Frame size	Reference
125 ... 630	B3 ... B5	1539 0012
800 ... 3200	B6 ... B8	1539 0080

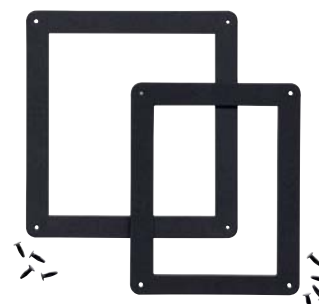

atys\_595\_a\_2\_cat

## 19.11. Auxiliary contacts (additional)

### Use

Pre breaking and signalling of positions I and II: each reference provides a single factory or customer fitted NO/NC contacts for both positions.

Low level auxiliary contacts: please consult us.

Rating (A)	Frame size	Nominal current (A)	Operating current I <sub>0</sub> (A)			
			250 VAC AC-13	400 VAC AC-13	24 VDC DC-13	48 VDC DC-13
125 ... 3200	B3 ... B8	16	12	8	14	6

Rating (A)	Frame size	Type of mounting	Reference
125 ... 630	B3 ... B5	Customer fitted	1599 0502 <sup>(1)</sup>
800 ... 1600	B6 ... B7	Customer fitted	1599 0532 <sup>(1)</sup>
2000 ... 3200	B8	-	included

(1) Up to 2 auxiliary contacts can be ordered.



access\_397\_a

access\_396\_a

## 19.12. Mounting spacers

### Use

Increases the distance between the rear power terminals and the backplate by 1 cm per spacer.

This accessory may also be used to replace the original mounting spacers.

Rating (A)	Frame size	Description of accessories	Reference
125 ... 630	B3 ... B5	1 set of 2 spacers	1509 0001



atys\_009\_b\_2\_cat

## 19.13. 3 position padlocking (I - 0 - II)

### Use

Enables the ATyS to be padlocked in the 3 positions 0, I and II (factory fitted).

Rating (A)	Frame size	Reference
125 ... 630	B3 ... B5	9599 0003
800 ... 3200	B6 ... B8	9599 0004



## 19.14. RONIS Key interlocking system

### Use

With the product in manual mode, it enables locking in position 0 using a RONIS EL11AP lock (factory fitted).

As standard, locking in position 0.

Optional padlocking in 3 positions: locking in position I, 0 or II.

Rating (A)	Frame size	Reference
125 ... 630	B3 ... B5	9599 1006
800 ... 3200	B6 ... B8	9599 1004



atys\_888\_a

## 19.15. Current transformers

### Use - For ATyS p only

Used with ATyS p switches, current transformers enable information to be obtained on the load current.

### Reference

Please see our general catalogue or our website [www.socomec.com](http://www.socomec.com)

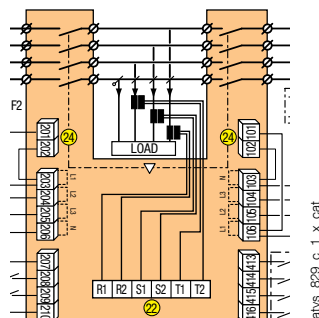

atys\_229\_c\_1\_x\_cat



trafo\_025\_a\_2\_cat



trafo\_077\_b\_1\_cat

## 19.16. Plug-in optional modules

Use - For ATyS p only

Number of usable modules per product:

A maximum of four modules can be fitted to each ATyS p, however with the installation of either Ethernet communication module only two additional modules can be installed. Only one pulse output, one analogue output and one communication module can be installed.

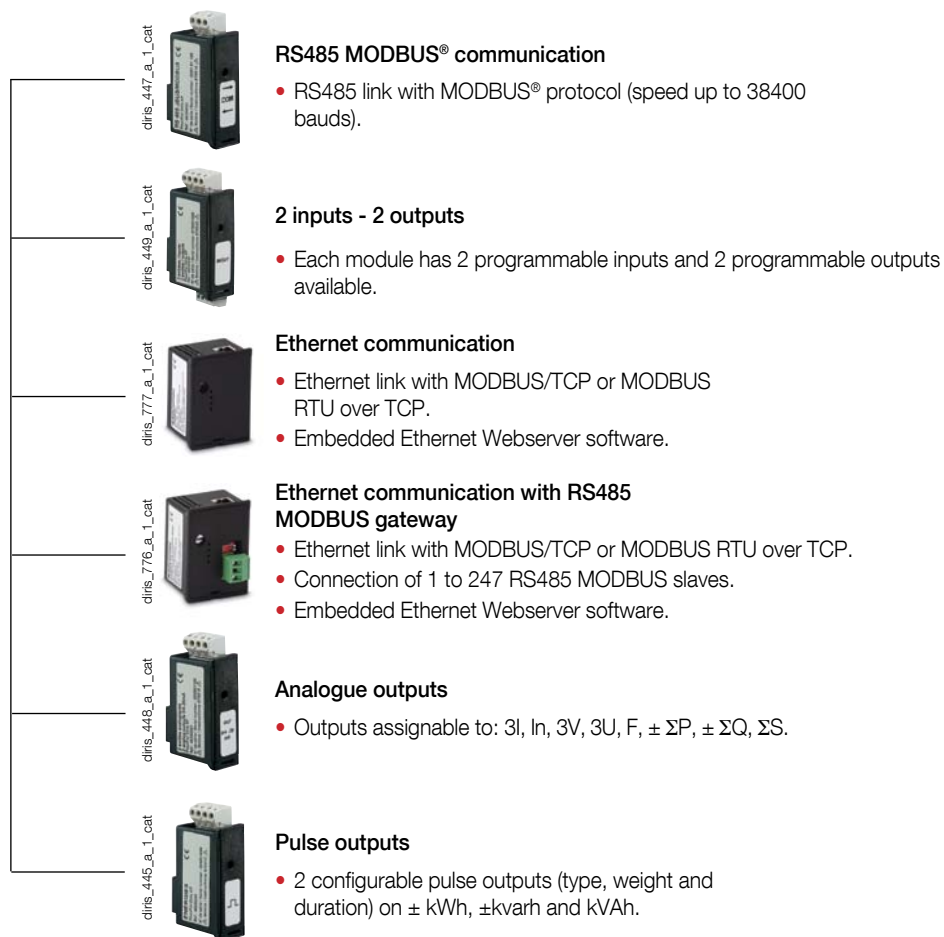

Description of accessories	Reference
RS485 MODBUS communication	4825 <b>0092</b>
2 inputs / 2 outputs	1599 <b>2001</b>
Ethernet communication (embedded Ethernet webserver software)	4825 <b>0203</b>
Ethernet communication + RS485 MODBUS gateway (embedded Ethernet webserver software)	4825 <b>0204</b>
Analogue outputs	4825 <b>0093</b>
Pulse outputs	4825 <b>0090</b>

## 19.17. Remote interface

### Use

To remotely display source availability and position indication typically used on the front of a panel when the product is enclosed.

Interfaces are powered from the ATyS transfer switch via the RJ45 connection cable.

Maximum cable length: 3 m.

### D10 - for ATyS d, t and g

To display source availability and position indication on the front panel of an enclosure. Protection degree: IP21.

### D20 - for ATyS p

In addition to the functions of the ATyS D10, the D20 displays measurements and enables control and configuration from the front of a panel.

Protection degree: IP21.

### Door mounting

2 holes Ø 22.5. ATyS transfer switch connection via RJ45 cable, not isolated. Cable available as an accessory.



Interfaces are powered from the ATyS



Drillings

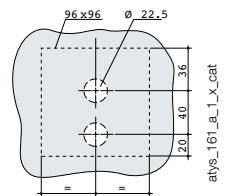

Description of accessories	Reference
D10	9599 2010
D20	9599 2020

## 19.18. Connection cable for remote interface

### Use

To connect between a remote interface (type D10 or D20) and an ATyS transfer switch (ATyS d, t, g or p).

### Characteristics

RJ45 8 wire straight-through, non isolated cable. Length 3m.

For ATyS d, t, g and p		
Type	Length	Reference
RJ45 cable	3 m	1599 2009



## 19.19. Auto/Manual key selector

### Use

Replaces the standard Auto/Manual selector knob with a key selector, providing added security by preventing unauthorised use of product. Customer assembly required.

Rating (A)	Frame size	Reference
125 ... 3200	B3 ... B8	9599 1007



## 20. Spare parts

### 20.1. Electronic module

The electronic module of ATyS d, t, g and p can be easily replaced in case of problems, even when the load is supplied.

Product model	References
ATyS d	9539 <b>2001</b>
ATyS t	9549 <b>2001</b>
ATyS g	9559 <b>2001</b>
ATyS p	9579 <b>2001</b>



atys\_601\_c\_1\_gb\_cat

### 20.2. Motorisation module

The motorisation module of ATyS r, d, t, g and p can be easily replaced in case of problems, even when the load is supplied.

Rating	References
125 ... 200 A	9509 <b>5020</b>
250 ... 400 A	9509 <b>5040</b>
500 ... 630 A	9509 <b>5063</b>
800 ... 1250 A	9509 <b>5120</b>
1600 A	9509 <b>5160</b>
2000 ... 3200 A	9509 <b>5320</b>



atys\_871\_a

### 20.3. Power section

References to be used for replacing the switching module of ATyS r, d, t, g or p. Please contact SOCOMEC.

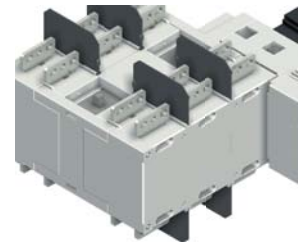

# 21. ATYS Family: ORDERING INFORMATION

The following is an ordering guide for ATYS Motorised Transfer Switches delivered inclusive of the emergency handle and storage clip. This guide is intended so as to explain the logic behind SOCOMEC ATYS reference numbers.

When ordering please consult the latest SOCOMEC catalogue.

## Typical UL 1008 (Optional Standby Power) ATYS reference



**97 2 3 4 0 1 0**

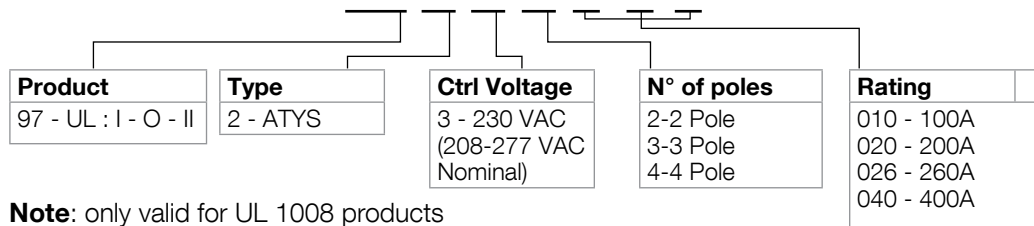

**Note:** only valid for UL 1008 products

## Typical IEC 60947-6-1 ATYS reference



**95 2 3 4 0 6 3**

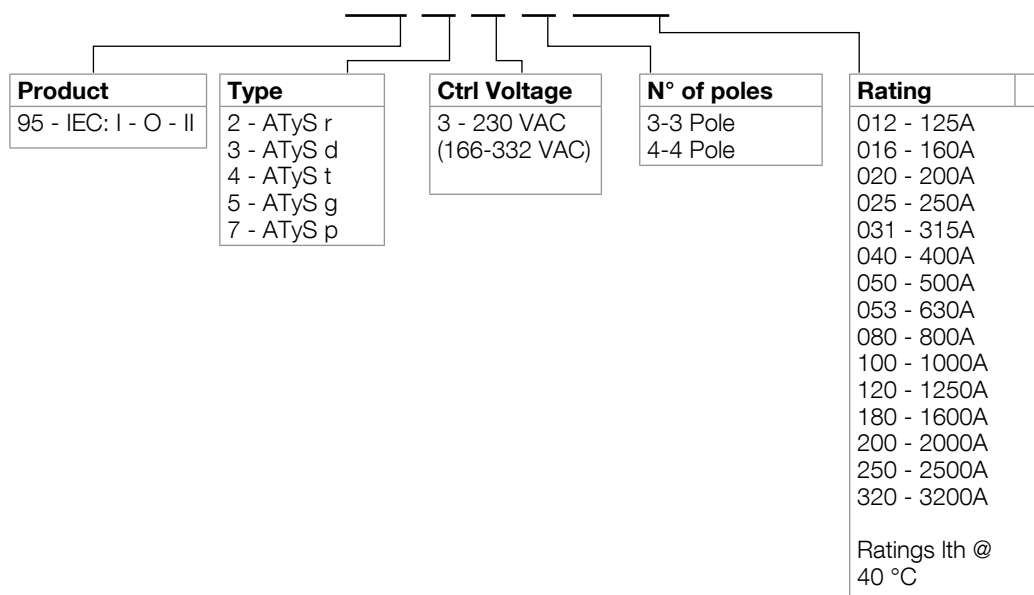



## Annexe I. Programming with the ATyS p keypad

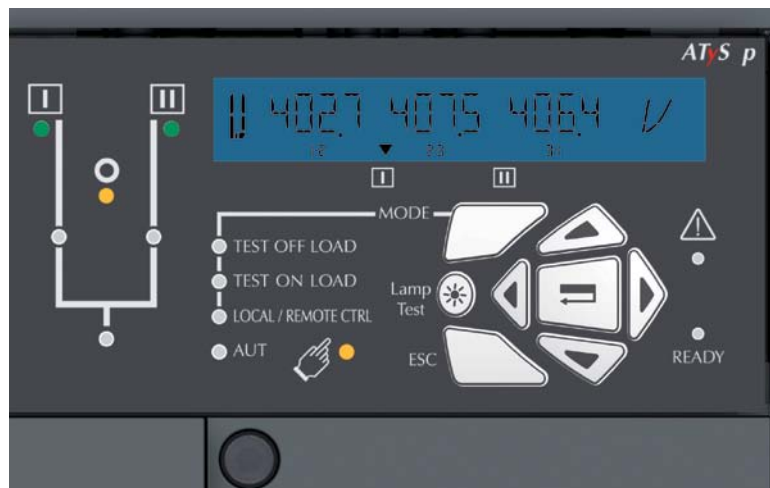

# Annexe I. Programming with the ATyS p keypad

## Annexe I - 1. Getting started - Software Version

When the ATyS p is powered for the first time the software version will be displayed on the LCD screen.

This is also displayed after a product reset.  
(A 3 minute power off will allow for this type of reset).

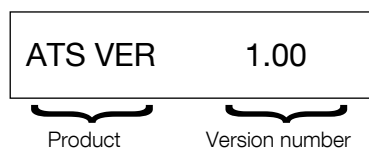

## Annexe I - 2. Keypad Operational Modes

### Annexe I - 2.1. VISUALISATION :

Measured values & parameter timers display.  
Always accessible without a password code.

### Annexe I - 2.2. OPERATION:

Test sequences or electrical control of the position.  
Password access (code 0000).

### Annexe I - 2.3. PROGRAMMING:

Parameters configuration.  
Password access (code 1000).

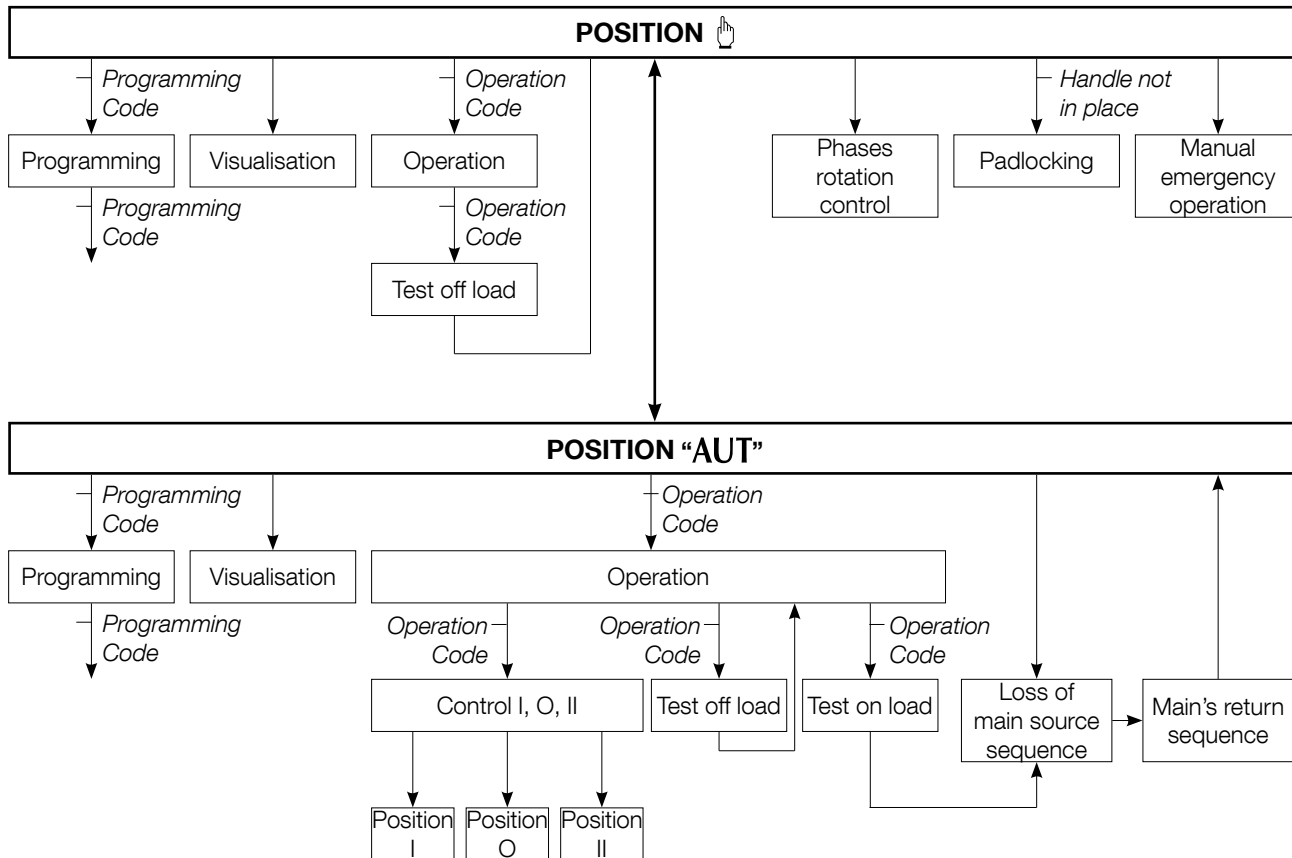

**NOTE:**

One can quit the menu without saving by pressing the ESC key.











## Annexe I - 3. Keypad programming - general information

Programming mode allows product parameter configuration through the keypad:

- It is always accessible when the product is in Manual position
- It is always accessible in AUT with the load on the priority source and priority source available.

The minimum configuration parameters that must be programmed before use are:

- type of network
- nominal voltage
- nominal frequency.

Navigation in the programming menu	
	<ul style="list-style-type: none"><li>• To enter the programming menu press and hold the validation key until “SETUP” appears on the screen.</li></ul>
 or 	<ul style="list-style-type: none"><li>• For parameter access: Press the “up – down” or “left – right” keys to navigate.</li></ul>
Programming	
	<ul style="list-style-type: none"><li>• Navigate to the parameter to be changed and press the validation key.</li></ul> <p><b>Note:</b> The product will request a password.</p>
 +  + 	<ul style="list-style-type: none"><li>• Input the password by using the “up – down” keys to change the value and the “left – right” keys to change the cursor position. (The default factory setting is 1000).</li><li>• Press the validation key to validate the password and enable programming.</li></ul>
 +  + 	<ul style="list-style-type: none"><li>• Change the parameter value by using the “up – down” keys to change the variable and the “left – right” keys to change the cursor position.</li><li>• Press the validation key to validate the change.</li><li>• If necessary, navigate to other parameters in the menu, change the value and validate each change.</li><li>• To save all changes, press and hold the validation key until “SAVED” is displayed.</li></ul> <p><b>Note:</b> After saving, “SAVED” will be displayed for 2s, the product will automatically exit programming mode and will then return to the main menu.</p>
Exiting programming mode without saving	
	<ul style="list-style-type: none"><li>• To quit programming mode without saving briefly press the “ESC” key. This will allow navigating back to the main menu.</li></ul> <p><b>Note:</b> Whilst in programming mode, should the product remain idle for longer than 2 minutes it will automatically exit and return to the main menu without saving.</p>

## Annexe I - 4. Parameter modifications

> Example:

To modify network nominal voltage from 400 to 230 V.

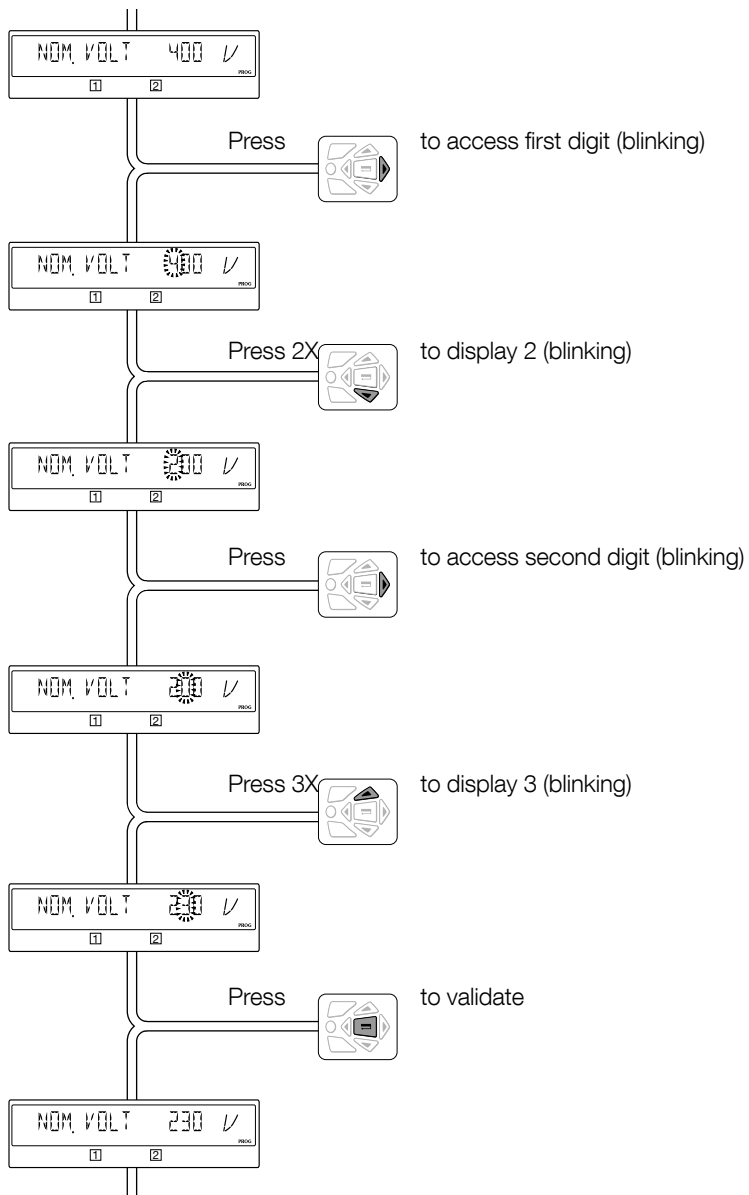





## Annexe I - 5. Configuration navigation screen

1	SETUP	2	VOLT. LEVELS	3	FREQ. LEVELS	4	PWR. LEVELS	5	TIMERS VALUE	6	I-O	7	COMM	8	DATE/TIME
NETWORK	4NBL	OV. U	I 115%	OV. F	I 105%	OV.P	I 0000 kVA	1FT	0003 SEC	IN 1	--- NO	DHCP	NO	(9)	YEAR
AUTOCONF	NO (7)	OV. U HYS	I 110%	OV. F HYS	I 103%	OV.P HYS	I 0000 kVA	1RT	0180 SEC	IN 2	--- NO	IP 1-2	192.168.	(9)	MONTH
NEUTRAL	AUTO	UND. U	I 085%	UND. F	I 095%	OV.P	II 0000 kVA	2FT	0003 SEC	IN 3	--- NO	IP 3-4	.002.001	(9)	DAY
ROT PH.	---	UND. U HYS	I 095%	UND. F HYS	I 097%	OV.P HYS	II 0000 kVA	2RT	0005 SEC (2)	IN 4	--- NO	GAT1-2	000.000.	(9)	HOUR
NOM. VOLT	400 V	UNB. U	I 00%	OV. F	II 105%			2AT	0005 SEC (1)	IN 5	--- NO	GAT3-4	.000.000	(9)	MINUTE
NOM. FREQ	50 Hz	UNB. U HYS	I 00%	OV. F HYS	II 103%			2CT	0180 SEC (1)	IN 6	--- NO	MSK1-2	255.255.	(9)	SECOND
APP	M-G	OV. U	II 115%	UND. F	II 095%			2ST	0030 SEC (1)	IN 7	--- NO (8)	MSK3-4	.255.000	(9)	
PRIO TON	NO (1)	OV. U HYS	II 110%	UND. F HYS	II 097%			ODT	0003 SEC	IN 8	--- NO (8)	ADDRESS	005		
PRIO EON	NO (3)	UND. U	II 085%					TOT	UNL (1)	IN 9	--- NO (8)	BDRATE	9600		
PRIO NET	1 (2)	UND. U HYS	II 095%					TOT	0010 SEC (1)	IN10	--- NO (8)	STOP BIT	1		
RETRANS	NO	UNB. U	II 00%					T3T	0000 SEC (1)	IN11	--- NO (8)	PARITY	NONE		
CT PRI	100	UNB. U HYS	II 00%					TFT	UNL (1)	IN12	--- NO (8)				
CT SEC	5							TFT	0600 SEC (1)	IN13	--- NO (8)				
S1=SW2	NO							E1T	0005 SEC (3)	IN14	--- NO (8)				
BACKLGHT	INT							E2T	UNL (3)	OUT 1	POP NO				
CODE P	1000							E2T	0010 SEC (3)	OUT 2	--- NO (8)				
CODE E	0000							E3T	0005 SEC (3)	OUT 3	--- NO (8)				
BACKUP	SAVE							E5T	0005 SEC (4)	OUT 4	--- NO (8)				
								E6T	LIM (4)	OUT 5	--- NO (8)				
								E6T	0600 SEC (4)	OUT 6	--- NO (8)				
								E7T	0005 SEC (4)	OUT 7	--- NO (8)				
								LST	0004 SEC (5)	OUT 8	--- NO (8)				
								EET	0168 H (6)	OUT 9	--- NO (8)				
								EDT	1800 SEC (6)						

- (1) When "APP" is set to "M-G"  
 (2) When "APP" is set to "M-M"  
 (3) When one of the I/P is set to "EON"  
 (4) When one of the I/P is set to "EOF"  
 (5) When one of the O/P is set to "LSC"  
 (6) When one of the O/P is set to "EES"  
 (7) If the product is in manual mode  
 (8) With optional I/O modules  
 (9) With Ethernet module  
 (10) Only if a communication module is used

**Setup by Auto Configuration**   
 (Volts, Hz, Neutral pos., Ph rotation)

Press 5s	
Go To	<b>1</b> SETUP
Scroll to	AUTOCONF
Enter code	1000
Set to	YES
Press 60 ms	
LEDs flash	
Save : press 5s	

**Note:** Source **I** or source **II** must be available to set by Auto Configuration.

## Annexe I - 6. Setup menu – keypad navigation

1 SETUP					
		Definition	Adjustment Range	M-G	M-M
NETWORK	4NBL	Network Type	1BL/2BL/2NBL/3BL/3NBL 4BL/4NBL/41NBL/42NBL	•	•
AUTOCONF	NO	Auto Configuration: (visible in manual mode) Network Voltage, Frequency, phase rotation and neutral position	NO YES	•	•
NEUTRAL	AUTO	Neutral Position: visible if the makes sense with the seleted network type. Neutral fixed on the LEFT - (N, L3, L2, L1) Neutral fixed on the RIGHT - (L1, L2, L3, N) Auto Detection of Neutral LEFT or RIGHT	LEFT RIGHT AUTO	•	•
ROT PH.	---	Select and Verify Phase Rotation as: compatible between S1 and S2, ABC or ACB visible if the makes sense with the seleted network type. It is also possible to check for consistency of direction of rotation between 2 sources (----). (Refer to ** Phase Rotation Check” below for details). Both supply sources must be present for this verification.	ABC ACB ----	•	•
NOM. VOLT	400 V	Nominal Network Voltage	1BL: 208-332V 2NBL: 416-600V Others: 360-575V	•	•
NOM. FREQ	50 Hz	Nominal Network Frequency	50Hz 60Hz	•	•
APP	M-G	Application Type: M – G: Main Network to Genset Supply M – M: Main to Main Supply	M – G M - M	•	•
PRIOTON	NO	In case of a Test On Load sequence, in case source 2 is no longer available you may: NO - Exit the test and switch to source 1 YES - Stay in position II  Note: The MSR input (refer to I/O Menu) takes priority over this parameter.	NO YES	•	
PRIOEON	NO	In case of an External Test On Load, in case source 2 is no longer available you may: NO - Exit the test and switch to source 1 YES - Stay in position II  Note: The MSR input (refer to I/O Menu) has priority over this parameter.	NO YES	•	
PRIO NET	1	This is to define the priority network: 1: Network 1 has priority 2: Network 2 has priority 0: Neither network has priority  Note: The PRI input (refer to menu I/O) has priority over this parameter. (Main – Main applications)	1 2 0		•
RETRANS	NO	Inhibit the automatic retransfer: NO: Automatic retransfer to the priority source YES: "Valid" or input RTC must be pressed to execute the return to priority.	NO YES	•	•
CT PRI	0000	Current Transformer primary rating	1 to 3200 A	•	•

1 SETUP					
		Definition	Adjustment Range	M-G	M-M
CT SEC	5	Current Transformer secondary rating	1 A 2 A	•	•
S1=SW2	NO	Inverted power section switch wiring. Switch 1 (Front) cabled as Switch 2 and Switch 2 (Back) cabled as Switch 1. NO: Not Inverted YES: Inverted	NO YES	•	•
BACKLGT	INT	The LCD backlight may be set to: OFF: Always Off ON: Always On INT: On after pressing the keypad and during operating sequences only. (Turned off after 2 minutes of inactivity).	OFF ON INT	•	•
CODE P	1000	Password Code to modify and save settings in Programming Mode. Default factory setting: 1000	0000 to 9999	•	•
CODE E	0000	Password Code to modify and save settings in Operating Mode. Default factory setting: 0000	0000 to 9999	•	•
BACKUP	SAVE	Save the settings in the backup so as to recall them later within the same menu. Load to charge the backup data	SAVE LOAD	•	•

### Annexe I - 6.1. \*\* Phase rotation check:

This functionality checks the consistency of phase rotation i.e. of the wiring prior to commissioning.

Example: If the parameter ROT PH = ABC:

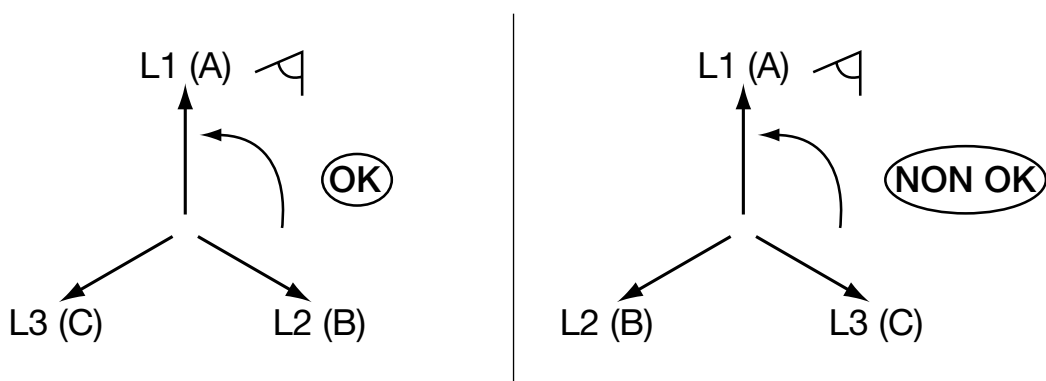

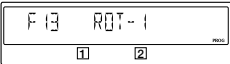
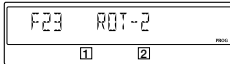
Display  or  depending on the non-compliant source (Rotation check on sources **1** and **2**).

 <b>WARNING</b>	Function available on both sources in case of 4NBL/4BL or 3NBL/3BL type of network and only on source <b>1</b> in case of 41NBL or 42NBL network.
--	---

## Annexe I - 7. Voltage levels menu – keypad navigation

2 VOLT. LEVELS						
			Definition	** Adjustment Range	M-G	M-M
OV. U	I	115%	Overvoltage threshold: Source Supply 1	102 – 130%	•	•
OV. U HYS	I	110%	Over-voltage hysteresis: Supply 1	101 – 129%	•	•
UND. U	I	085%	Undervoltage threshold: Supply 1	60 – 98%	•	•
UND. U HYS	I	095%	Undervoltage hysteresis: Supply 1	61 – 99%	•	•
UNB. U	I	00%	Phase unbalance threshold: Supply 1 Refer to next paragraph for further details	0 – 30%	•	•
UNB. U HYS	I	00%	Hysteresis unbalance threshold: Supply 1 Refer to next paragraph for further details	0 – 29%	•	•
OV. U	II	115%	Overvoltage threshold: Source Supply 2	102 – 130%	•	•
OV. U HYS	II	110%	Over-voltage hysteresis: Supply 2	101 – 129%	•	•
UND. U	II	085%	Undervoltage threshold: Supply 2	60 – 98%	•	•
UND. U HYS	II	095%	Undervoltage hysteresis: Supply 2	61 – 99%	•	•
UNB. U	II	00%	Phase unbalance threshold: Supply 2 Refer to next paragraph for further details	0 – 30%	•	•
UNB. U HYS	II	00%	Hysteresis unbalance threshold: Supply 2 Refer to next paragraph for further details. Note 0% = function disactivated	0 – 29%	•	•

\*\* Adjustment range given:

- As a % of U nominal for Over and Undervoltage
- As a % of U avg in case of unbalances.

### Annexe I - 7.1. Over-voltage and under-voltage

The thresholds and hystereses are defined as percentages of nominal voltage.

The hystereses define return to normal levels following an under-voltage or over-voltage.

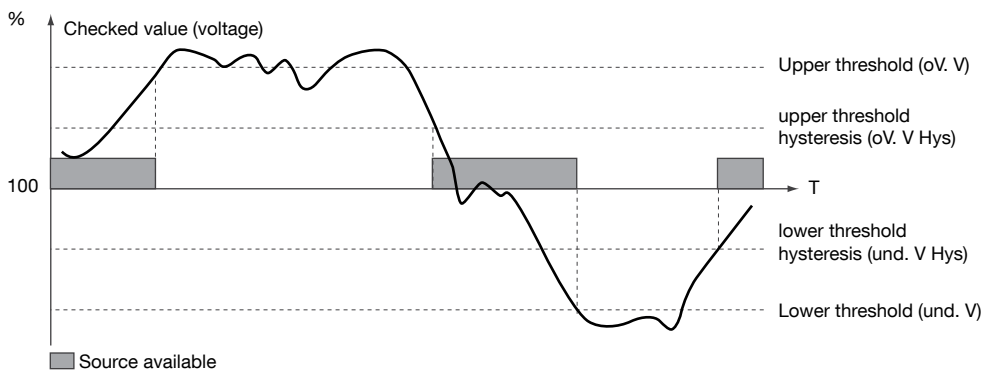



## Annexe I - 7.2. Voltage unbalance measurement

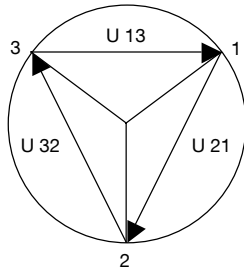

Balanced network

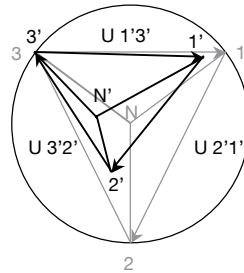

Unbalanced network

## Annexe I - 8. Frequency levels menu – keypad navigation

3 FREQ. LEVELS						
			Definition	** Adjustment Range	M-G	M-M
OV. F	I	105%	Over Frequency Threshold: Source 1	102 – 130%	•	•
OV. F HYS	I	103%	Over Frequency Hysteresis: Source 1	101 – 129%	•	•
UND. F	I	095%	Under Frequency Threshold: Source 1	60 – 98%	•	•
UND. F HYS	I	097%	Under Frequency Hysteresis: Source 1	61 – 99%	•	•
OV. F	II	105%	Over Frequency Threshold: Source 2	102 – 130%	•	•
OV. F HYS	II	103%	Over Frequency Hysteresis: Source 2	101 – 129%	•	•
UND. F	II	095%	Under Frequency Threshold: Source 2	60 – 98%	•	•
UND. F HYS	II	097%	Under Frequency Hysteresis: Source 2	61 – 99%	•	•

\*\* Adjustment range given:

- As a % of nominal frequency

## Annexe I - 8.1. Under-frequency or over-frequency

The thresholds and hysteresis are defined as percentages of nominal frequency.

The hysteresis define return to normal levels following an under-frequency or over-frequency.

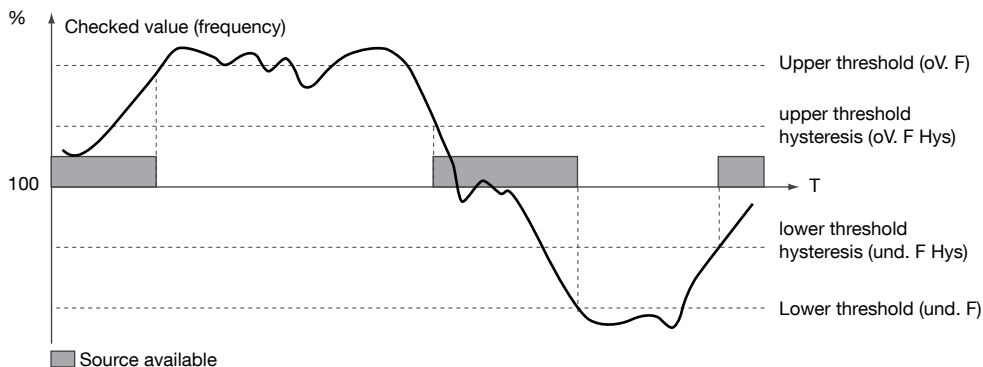

## Annexe I - 9. Power levels menu – keypad navigation

Power level settings are set so as to define the source supply power ratings for metering purposes and for capacity management through load shedding. A metering power bar graph may be visualized through Webserver when the ATyS p is equipped with the optional Ethernet module.

4 PWR. LEVELS						
			Definition	** Adjustment Range	M-G	M-M
OV.P	I	0000 kVA	Supply Nominal Power Rating: Source 1 (Threshold)	0 to 2000kva	•	•
OV.P HYS	I	0000 kVA	Supply Nominal Power Hysteresis: Source 1 (Related to Load Shedding 2)	0 to 2000kva	•	•
OV.P	II	0000 kVA	Supply Nominal Power Rating: Source 2 (Threshold)	0 to 2000kva	•	•
OV.P HYS	II	0000 kVA	Supply Nominal Power Hysteresis: Source 2 (Related to Load Shedding 2)	0 to 2000kva	•	•

\*\* Note: When set to “0” kva the power management function is disabled.

## Annexe I - 10. Timers menu – keypad navigation

5 TIMERS VALUE						
			Definition	Adjustment Range	M-G	M-M
1FT	0003 SEC		Source 1 Failure Timer: When source 1 is considered lost, 1FT is started. If source 1 is considered restored before the end of 1FT, the changeover sequence will not be engaged.	0 – 60 seconds	•	•
1RT	0180 SEC		Source 1 Return Timer: When source 1 returns, 1RT is started. At the end of 1RT, source 1 is then considered to be present. Should source 1 disappear before the end of 1RT, the changeover will not be carried out. In case the alternate source disappears during 1RT, a dynamic 3 second delay will override the 1RT time setting value.	0 – 3600 seconds	•	•
2FT	0003 SEC		Source 2 Failure Timer: When source 2 is lost, 2FT is started. If source 2 is restored before the end of 2FT, the changeover sequence is not started.	0 – 60 seconds	•	•
2RT	0005 SEC		Source 2 Return Timer: When source 2 returns, 2RT is started. At the end of 2RT, source 2 is then considered to be present. Should source 2 disappear before the end of 2RT, the changeover will not be carried out.	0 – 3600 seconds		•
2AT	0005 SEC		Source 2 (Genset) Available Timer: In order for the transfer to the generator supply to be achieved, the voltage and frequency of this source must be within threshold limits (healthy) for the duration of this timer.	0 – 3600 seconds	•	
2CT	0180 SEC		Source 2 (Genset) Cool Down Timer: Following a return to source 1 sequence, the genset on source 2 is kept running for the 2CT timer duration. This is intended to cool down the genset (off load) before switching off.	0 – 600 Seconds	•	

5 TIMERS VALUE					
		Definition	Adjustment Range	M-G	M-M
2ST	0030 SEC	Source 2 (Genset) Starting Timeout Notification: Timer countdown begins as soon as the genset start order has been given. If 2AT has not been satisfied before the countdown of this timer, the message "FAIL START" will be displayed. In order for the FAIL START message not to be displayed, the generator must have started and be considered available within this time. <b>Note: The display of this notification does not affect the operation of the ATS.</b>	0 – 600 Seconds	•	
ODT	0003 SEC	Dead Band Timer This is the minimum load supply blackout time allowing residual voltages that may be generated by the load (such as motors) to decay. This is not necessarily a stop in 0 position, when a transfer is initiated after a loss of source, the timer starts at the same time as 1FT/2FT.	0 – 20 seconds	•	•
TOT	UNL	Test On Load Limited (LIM) / Unlimited (UNL) duration. LIM is to be selected when associating the test to a duration timer such as TOT. <b>Note 1: If the value is set at UNL, the TOT is stopped either when the input is opened, or via the validation key.</b> <b>Note 2: When set to UNL, the test on load duration timer is deactivated as the duration becomes unlimited.</b> <b>ATTN: Set to UNL when using the engine exerciser</b>	LIM (Limited) UNL (Unlimited)	•	
TOT	0000 SEC	Test On Load Duration Timer: This timer defines the On Load Test time. It starts counting when the Test is initiated. <b>Note: TOT is visible in the timers menu when TOT (LIM/UNL) above is set to LIM.</b>	0 – 1800 seconds	•	
T3T	0000 SEC	Test On Load – End Delay Timer: This time delay starts counting at the end of TOT Timer. The return to the main supply takes place at the end of T3T time.	0 – 1800 seconds	•	
TFT	UNL	Test Off Load Limited (LIM) / Unlimited (UNL) duration. LIM is to be selected when associating the test to a duration timer such as TFT below. <b>Note 1: If the value is set at UNL, the TFT is stopped either when the input is opened, or via the validation key.</b> <b>Note 2: When set to UNL, the test on load duration timer is deactivated as the duration becomes unlimited.</b> <b>ATTN: Set to UNL when using the engine exerciser</b>	LIM (Limited) UNL (Unlimited)	•	
TFT	0600 SEC	Test Off Load - Duration Timer: This time delay defines the On Load Test time. It starts counting when the Test is initiated. The return to the main supply takes place at the end of TFT. <b>Note: TFT is visible in the timers menu when TOT (LIM/UNL) above is set to LIM.</b>	0 – 1800 seconds	•	
E1T	0005 SEC	External Order Test On Load - Start Delay Timer. This time delay starts at the same time as the External On Load Test (EON) order is received. At the end of this time delay, the Genset start order is activated. Once source supply 2 is available, the load is transferred to source supply 2. <b>Note: E1T is visible in the timers menu when at least 1 input is configured as EON.</b>	0 – 1800 seconds	•	

5 TIMERS VALUE					
		Definition	Adjustment Range	M-G	M-M
E2T	UNL	External Order Test On Load Limited (LIM) / Unlimited (UNL) duration. LIM is to be selected when associating the test to a duration timer such as E2T below. When set to UNL, the test on load duration timer is deactivated as the duration becomes unlimited. <b>Note 1: If the value is set at UNL, the TOT is stopped either when the input is opened, or via the validation key.</b> <b>Note 2: E2T is visible in the timers menu when at least 1 input is configured as EON.</b>	LIM (Limited) UNL (Unlimited)	•	
E2T	0010 SEC	External Order Test On Load - Duration Timer: This timer starts counting when the Test is initiated. <b>Note: E2T duration timer is visible in the timers menu when at least 1 input is configured as EON and with E2T (UNL/LIM) set to LIM.</b>	0 – 1800 seconds	•	
E3T	0005 SEC	External Order Test On Load – End Delay Timer: This time delay starts counting at the end of E2T Timer. The return to the main supply takes place at the end of E3T time. <b>Note: E3T duration timer is visible in the timers menu when at least 1 input is configured as EON and with E2T (UNL/LIM) set to UNL.</b>	0 – 1800 seconds	•	
E5T	0005 SEC	External Order Test Off Load - Start Delay Timer. This time delay starts at the same time as the External On Load (EOF) order is received. At the end of this time delay, the Genset start order is activated. The load will not be transferred to the Genset supply. <b>Note: E5T is visible in the timers menu when at least 1 input is configured as EON.</b>	0 – 1800 seconds	•	
E6T	LIM	External Order Test Off Load Limited (LIM) / Unlimited (UNL) duration. LIM is to be selected when associating the test to a duration timer such as E6T below. When set to UNL, the test off load duration timer is deactivated as the duration becomes unlimited. <b>Note 1: If the value is set at UNL, E5T is stopped either when the input is opened, or via the validation key.</b> <b>Note 2: E6T is visible in the timers menu when at least 1 input is configured as EOF.</b>	LIM (Limited) UNL (Unlimited)	•	
E6T	0600 SEC	External Order Test Off Load - Duration Timer: This timer starts counting when the Test is initiated. <b>Note: E6T is visible in the timers menu when at least 1 input is configured as EOF.</b>	0 – 1800 seconds	•	
E7T	0005 SEC	External Order Test On Load – End Delay Timer: This time delay starts counting at the end of E6T Timer. The Genset signal will switch at the end E7T. <b>Note: E7T is visible in the timers menu when at least 1 input is configured as EOF.</b>	0 – 1800 seconds	•	
LST	0004 SEC	Load Shedding - Time Delay (before transfer) Timer. This time delay corresponds to the time available to perform any load shedding operations downstream before the ATyS switch to position II. <b>Note: The ATS can switch to position 0 but will not switch to the alternative source until LST has reached zero.</b>	0 – 60 seconds	•	•
EET	0168 H	S2 maximum reset timer - Battery Charger maximum Off Timer. This timer defines, the minimum time that the Genset must be switched off for output EES (Battery Charger Signal) to be activated.	0 – 168hrs	•	

5 TIMERS VALUE					
		Definition	Adjustment Range	M-G	M-M
EDT	0000 SEC	S2 Run Timer - Battery Charger run timer.	0 – 9999 seconds	•	

**Note:**

It is recommended configure the inputs and outputs before the timers. All timers used with programmable outputs will only be active and visible to set the timings after the associated output has been configured.

## Annexe I - 11. I/O Menu – Keypad navigation

6 I-O						
			Definition	Adjustment Range	M-G	M-M
IN 1	---	NO	Internal: Programmable Input number 1	Normally Open / Normally Closed: Refer to the list below for Input type details.	•	•
IN 2	---	NO	Programmable Input number 2	Normally Open / Normally Closed: Refer to the list below for Input type details.	•	•
IN 3	---	NO	Programmable Input number 3	Normally Open / Normally Closed: Refer to the list below for Input type details.	•	•
IN 4	---	NO	Programmable Input number 4	Normally Open / Normally Closed: Refer to the list below for Input type details.	•	•
IN 5	---	NO	Programmable Input number 5	Normally Open / Normally Closed: Refer to the list below for Input type details.	•	•
IN 6	---	NO	Programmable Input number 6	Normally Open / Normally Closed: Refer to the list below for Input type details.	•	•
IN 7	---	NO	Programmable Input number 7	Normally Open / Normally Closed: Refer to the list below for Input type details.	•	•
IN 8	---	NO	Programmable Input number 8	Normally Open / Normally Closed: Refer to the list below for Input type details.	•	•
IN 9	---	NO	Programmable Input number 9	Normally Open / Normally Closed: Refer to the list below for Input type details.	•	•
IN10	---	NO	Programmable Input number 10	Normally Open / Normally Closed: Refer to the list below for Input type details.	•	•
IN11	---	NO	Programmable Input number 11	Normally Open / Normally Closed: Refer to the list below for Input type details.	•	•

6 I-O						
			Definition	Adjustment Range	M-G	M-M
IN12	---	NO	Programmable Input number 12	Normally Open / Normally Closed: Refer to the list below for Input type details.	•	•
IN13	---	NO	Programmable Input number 13	Normally Open / Normally Closed: Refer to the list below for Input type details.	•	•
IN14	---	NO	Programmable Input number 14	Normally Open / Normally Closed: Refer to the list below for Input type details.	•	•
OUT 1	POP	NO	Programmable Output number 1	Normally Open / Normally Closed: Refer to the list below for Input type details.	•	•
OUT 2	---	NO	Programmable Output number 2	Normally Open / Normally Closed: Refer to the list below for Input type details.	•	•
OUT 3	---	NO	Programmable Output number 3	Normally Open / Normally Closed: Refer to the list below for Input type details.	•	•
OUT 4	---	NO	Programmable Output number 4	Normally Open / Normally Closed: Refer to the list below for Input type details.	•	•
OUT 5	---	NO	Programmable Output number 5	Normally Open / Normally Closed: Refer to the list below for Input type details.	•	•
OUT 6	---	NO	Programmable Output number 6	Normally Open / Normally Closed: Refer to the list below for Input type details.	•	•
OUT 7	---	NO	Programmable Output number 7	Normally Open / Normally Closed: Refer to the list below for Input type details.	•	•
OUT 8	---	NO	Programmable Output number 8	Normally Open / Normally Closed: Refer to the list below for Input type details.	•	•
OUT 9	---	NO	Programmable Output number 9	Normally Open / Normally Closed: Refer to the list below for Input type details.	•	•

## Annexe I - 11.1. Programmable inputs

There are 6 internal programmable inputs built into the ATS controller as standard. External programmable inputs (up to 8) are the optional add-on I/O modules that may be fixed to the ATS controller using slots 1 to slot 4.

The list of available inputs is selected from the following options below. Depending on user requirements, the same function may be applied to more than 1 input.

	INPUT Code Definition	Adjustment Range	M-G	M-M
INH	<p><b>Inhibition of the Automatic Operation:</b> All automatic commands relative to the transfer switch, but excluding the Genset Start signal, will be inhibited.</p> <p><i>Note: With INH closed, the generator will start if the network is lost but the switch will not transfer position.</i></p>	NO / NC (Normally Open or Normally Closed)	•	•
TON	<p><b>Test On-Load:</b> Activates an on load test. Retransfer remains locked until the contact is opened.</p>	NO / NC	•	
TOF	<p><b>Test Off-Load:</b> Activates an off load test. This will start and stop the generator without transferring the load to S2.</p>	NO / NC	•	
EON	<p><b>External Test On load operation request, (delayable) :</b> Activates an operating cycle depending on time delays E1T, E2T, E3T. These time delays must be set in the TIMERS menu. Refer to the graphs below for operation details.</p> <p><i>Note: This input function together with the associated time delays (E1T, E2T, E3T) are particularly useful for peak shaving.</i></p>	NO / NC	•	
EOF	<p><b>External Test Off load operation request, (delayable) :</b> Activates "Start Gen" contact according to time delays. These time delays must be set in the TIMERS menu E5T, E6T et E7T. The operation is the same as for EON but without the load switching over to the Genset, (S2).</p>	NO / NC	•	
RTC	<p><b>Remote transfer back to the priority source:</b> This is the same function as "RETRANS" cleared with the keypad. This variable in the SETUP menu must be "YES" to validate the operation through this input.</p>	NO / NC	•	•
PRI	<p><b>Priority to Source 2 :</b> By default the priority source on the ATyS p is S1. Input PRI will set the priority to S2. This input takes priority over PRIO NET in the SETUP menu.</p>	NO / NC		•
SS1 SS2	<p><b>Voltage Stabilisation time delay relay bypass :</b> These inputs allow to initiate the transfer from one source to the other before the end of the time delay 1RT/2RT/2AT.</p>	NO / NC	•	•
AL1 AL2	<p><b>External Alarm for Source 1 and Source 2:</b> This input will flash the "Fault LED" on the front of the ATyS p ATS controller and will indicate F12 ALR - 1 / F22 ALR - 2 on the screen. This message will disappear when the external alarm is cleared by opening the input contact.</p> <p><i>Note: These alarms do not trigger any position change in the switch but the product not available output will be activated.</i></p>	NO / NC	•	•
FT1 FT2	<p><b>External Fault Source 1 or source 2 with zero return :</b> This input will flash the "Fault LED" on the front of the ATyS p ATS controller and will indicate F11 FLT - 1 / F21 FLT - 2 on the LCD screen. This message will disappear after validation and RESET through input RST, by changing the selector switch from AUT to Manu and back to AUT or via communication after the fault has been cleared.</p> <p><i>Note: Immediately upon activation of one of these inputs the ATyS p will changeover to the 0 position. Time delays 10T or 20T time delay will not be considered.</i></p>	NO / NC	•	•
MSR	<p><b>Hold on S2 (Genset) with priority to TON and EON :</b> During a Test On Load (TON) or an external Test On Load (EON), validating MSR will force the ATyS p to remain on source 2 for as long as TON or EON are active. The switch will remain on S2 even if the Genset supply is lost.</p>	NO / NC	•	
OA1 OA2	<p><b>Define Source 1 and/or Source 2 as available :</b> This is an external input used to bypass the internal voltage sensing and timers. These inputs will define S1 and/or S2 available immaterial of the value and immaterial of timers 1RT, 2RT, 2AT.</p>	NO / NC	•	•
RST	<p><b>Fault Reset :</b> This input may be used to reset a fault condition after the fault has been cleared. Faults may also be reset through communication or by shifting the front selector switch on the ATyS p from AUT to Manu and back to the AUT position.</p>	NO / NC	•	•
LSI	<p><b>Pre transfer signal LSC time delay (load shedding 1) bypass :</b> This input will bypass the LSC time delay, thereby confirming that the load is OK (Shed or within an acceptable range) and the changeover to source 2 may begin immediately. Only visible after activating at least one output as LSC.</p>	NO / NC	•	•

	INPUT Code Definition	Adjustment Range	M-G	M-M
CHP	<b>Change of position</b> Once this input is active the automatism is inhibited and the product transfers on the opposite solution (From I to II and from II to I). If the product is in 0 when the input is activated then the automatism is inhibited, but the product won't transfer. When the input is deactivated the product goes back in Automatic mode.	NO / NC		•

## Annexe I - 11.2. Operation of the EON function:

E2T when set as Limited

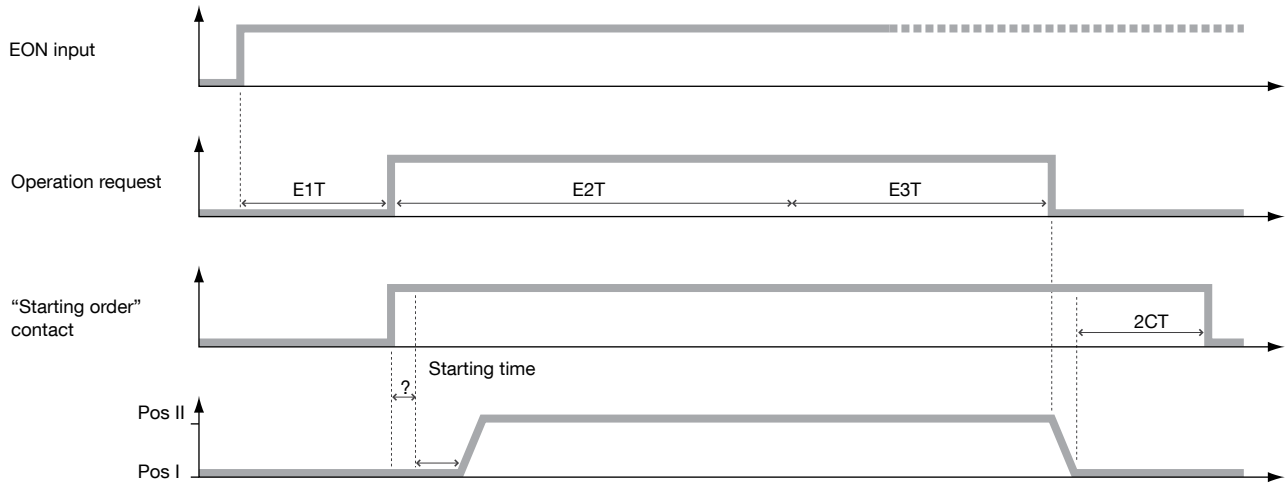

E2T takes priority over EON if E2T is set as LIM (Limited)

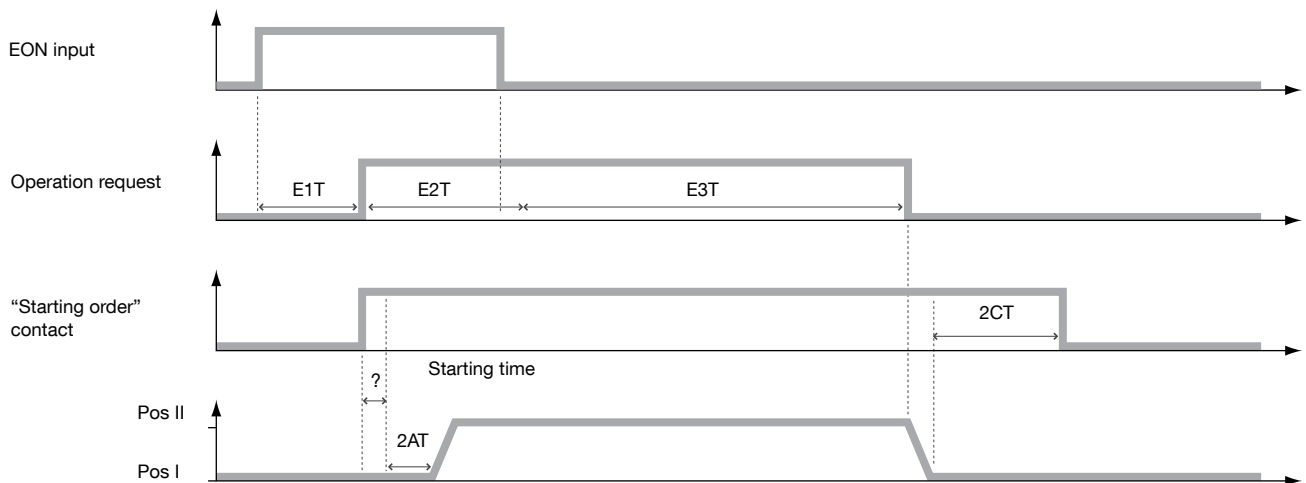



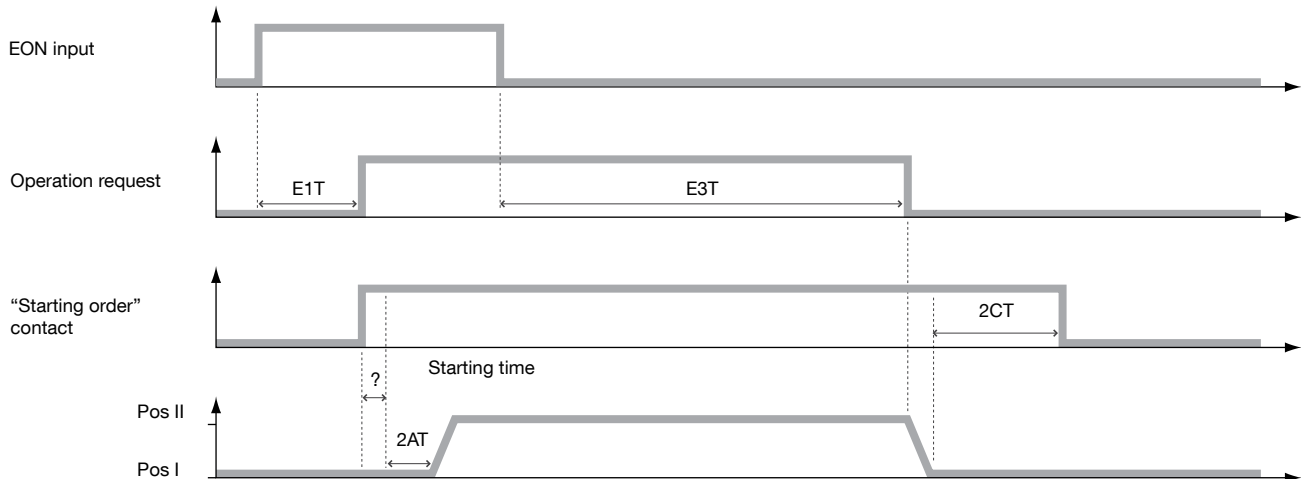

EON takes priority over E2T if E2T is set as UNL (Unlimited)



## Annexe I - 11.3. Programmable outputs

	Output Code Definition	Adjustment Range	M-G	M-M
S1A	<b>Source 1 available output:</b> This output is activated when source 1 is available.	NO / NC	•	•
S2A	<b>Source 2 available output:</b> This output is activated when source 2 is available.	NO / NC	•	•
SCA	<b>Source 1 or Source 2 available output :</b> This output is activated when at least one source (S1 or S2) is available.	NO / NC	•	•
AC1	<b>Switch Position I auxiliary contact :</b> This output is activated when the switch is in position I.	NO / NC	•	•
AC2	<b>Switch Position II auxiliary contact :</b> This output is activated when the switch is in position II.	NO / NC	•	•
AC0	<b>Switch Position 0 auxiliary contact :</b> This output is activated when the switch is in position 0.	NO / NC	•	•
LO1	<b>Load being supplied by source 1:</b> Indicates which source is supplying the load. This output is activated when the switch is in Position I and Source 1 is available. (LO1 activated = AC1 and S1A activated).	NO / NC	•	•
LO2	<b>Load being supplied by source 2:</b> Indicates which source is supplying the load. This output is activated when the switch is in Position II and Source 2 is available. (LO2 activated = AC2 and S2A activated).	NO / NC	•	•
LSC	<b>Load shedding before transfer output command :</b> This output will initiate load shedding prior to the transfer from source 1 to a backup (usually smaller) power source. After restoration this output may also be used to signal reloading. For further details refer to the diagrams below.	NO / NC	•	•
FLT	<b>Fault condition output:</b> This output is activated when at least one type of fault (internal or external) is activated.	NO / NC	•	•
POP	<b>Product Available (No Fault):</b> This output is activated when the ATyS p (ATS Controller) is considered to be operational and ready to switch positions.	NO / NC	•	•
CO1 to CO14	<b>Copy Input to the corresponding Output:</b> The output adopts the same state as the corresponding input. This is the same function as relaying.	NO / NC	•	•
LCK	<b>Product Locked output:</b> Output linked to the padlocked state of the ATyS p. (Product in manual mode with the padlocking mechanism pulled out.	NO / NC	•	•

	<b>Output Code Definition</b>	<b>Adjustment Range</b>	<b>M-G</b>	<b>M-M</b>
PTS	<b>Power Threshold Exceeded (Load Shedding 2):</b> This output signal is linked to the kva ratings as configured in the Power Level settings menu. When the power drawn by the load exceeds the threshold levels set output PTS will be activated so as to load shed selected loads.	NO / NC	•	•
EES	<b>Battery Charge Output signal:</b> This output will be activated when the maximum reset timer EET elapses. This output may be used with a battery charger that will be switched on depending on the Genset idle time. Output EES will be deactivated when the battery charge run timer (EDT) elapses.	NO / NC	•	
COP	<b>Controller Available</b> This output is activated when the ATS controller of the ATyS p is considered to be operational and ready to switch positions.	NO / NC	•	•
MAN	<b>Product in Manual Mode</b> This output is activated when the product is in Manual Mode (Selector in MAN position).	NO / NC	•	•

**Note:**

The Engine Exerciser settings are only accessible through Webserver and through Easy Config programming software. Refer to the Easy Config section for details.

## Annexe I - 11.4. Operation of load shedding before transfer

If output LSC is selected, (load shedding before transfer request), the associated time delay LST (maximum duration of the load shedding) must be programmed in the Timers Menu.

### Scenario 1 with LSI active

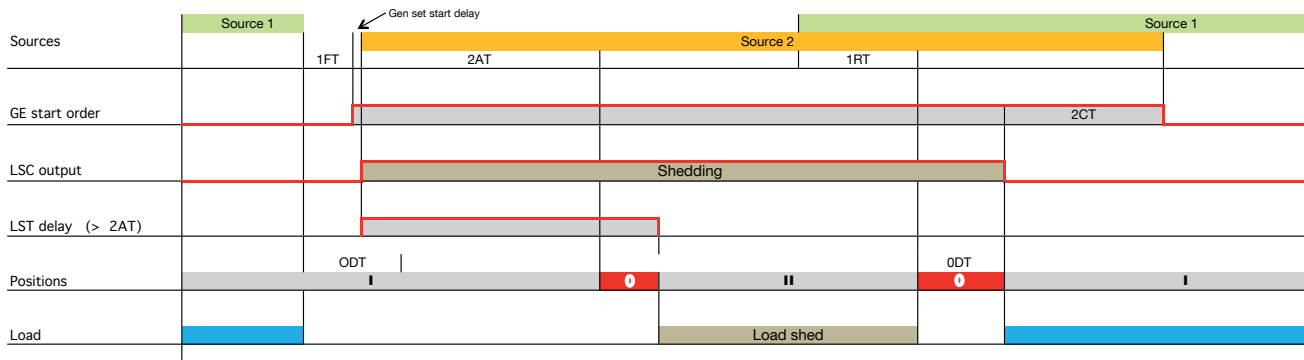

### Scenario 2: LSI Input not activated

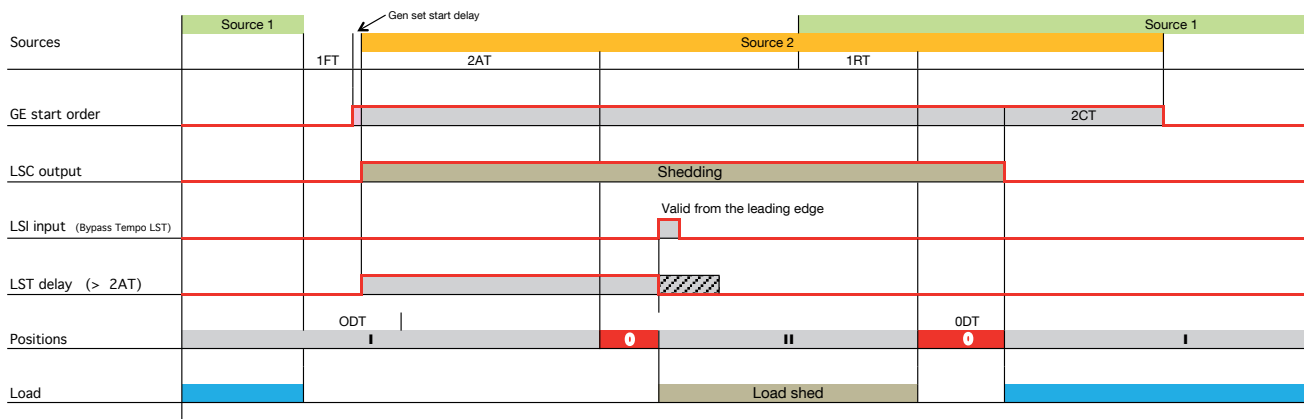

## Annexe I - 12. Communication menu – keypad navigation

7 COMM		Definition	Adjustment Range
DHCP	NO	Dynamic Host Configuration Protocol	YES / NO
IP 1-2	192.168.	IP Address Line 1	-
IP 3-4	.002.001	IP Address Line 2	-
GAT1-2	000.000.	Gate Line 1	-
GAT3-4	.000.000	Gate Line 2	-
MSK1-2	255.255.	Mask Line 1	-
MSK3-4	.255.000	Mask Line 2	-
ADDRESS	005	ATyS p Device network address:	1 to 255
BDRATE	9600	Baud rate :	9600, 19200 38400
STOP BIT	1	Stop Bit Setting	1, 2

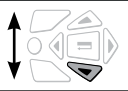
7 COMM			
		Definition	Adjustment Range
PARITY	NONE	Parity Type: NO -> No parity bit ODD -> Odd parity bit EVEN -> Even parity bit	NO, ODD, EVE

**Note:** The COMM menu will only be visible and accessible when an optional communication module (Ethernet or MODBUS) is installed on the product.

## Annexe I - 13. Date and Time – keypad navigation

8 DATE/TIME			
		Definition	Adjustment Range
YEAR		Set the year:	00-99
MONTH		Set the month:	01-12
DAY		Set the day :	00-23
HOUR		Set the hour :	00-23
MINUTE		Set the minute :	00-59
SECOND		Set the seconds :	00-59

## Annexe I - 14. Pulse module – keypad navigation

This menu appears only when a Pulse module is connected

9 PULSE			
		Definition	Adjustment Range
PUL1 TYP		Pulse activation	EA+; AQ+; ES; EA-; EQ-
PUL1 W		Pulse value	0.1; 1; 10; 100; 1000; 10000
PUL1 DUR		Pulse duration	200; 300; 400; 500; 600; 700; 800; 900
PUL2 TYP		Pulse activation	EA+; EQ+; ES; EA-; EQ-
PUL2 W		Pulse value	0.1; 1; 10; 100; 1000; 10000
PUL2 DUR		Pulse duration	200; 300; 400; 500; 600; 700; 800; 900

## Annexe II. MODBUS® Communication address and designation details



# Annexe II. MODBUS® Communication address and designation details

**Note:** To authorise a change in configuration: define adress HEXA E300 as 1000.

## Annexe II - 1. Metrology Affected by current and voltage transformers

Function 3 Codes

Dec. Address	Hex. Address	Words count	Description	Unit
50514	C552	2	Phase to Phase Voltage: U12 (load)	V/100
50516	C554	2	Phase to Phase Voltage: U23 (load)	V/100
50518	C556	2	Phase to Phase Voltage: U31 (load)	V/100
50520	C558	2	Simple voltage: V1 (load)	V/100
50522	C55A	2	Simple voltage: V2 (load)	V/100
50524	C55C	2	Simple voltage: V3 (load)	V/100
50526	C55E	2	Frequency: F	Hz/100
50528	C560	2	Current: I1	mA
50530	C562	2	Current: I2	mA
50532	C564	2	Current: I3	mA
50534	C566	2	Neutral Current: In	mA
50536	C568	2	$\sum$ Active Power $\pm$ : P	kW/100 (Signed)
50538	C56A	2	$\sum$ Reactive Power $\pm$ : Q	kvar/100 (Signed)
50540	C56C	2	$\sum$ Apparent Power: S	kVA/100
50542	C56E	2	$\sum$ Power Factor: -: leading et +: lagging: PF	0,001 (Signed)
50544	C570	2	Active Power phase 1 $\pm$ : P1	kW/100 (Signed)
50546	C572	2	Active Power phase 2 $\pm$ : P2	kW/100 (Signed)
50548	C574	2	Active Power phase 3 $\pm$ : P3	kW/100 (Signed)
50550	C576	2	Reactive Power phase 1 $\pm$ : Q1	kvar/100 (Signed)
50552	C578	2	Reactive Power phase 2 $\pm$ : Q2	kvar/100 (Signed)
50554	C57A	2	Reactive Power phase 3 $\pm$ : Q3	kvar/100 (Signed)
50556	C57C	2	Apparent Power phase 1: S1	kVA/100
50558	C57E	2	Apparent Power phase 2: S2	kVA/100
50560	C580	2	Apparent Power phase 3: S3	kVA/100
50562	C582	2	Power Factor phase 1 -: leading and +: lagging : PF1	0,001 (Signed)
50564	C584	2	Power Factor phase 2 -: leading and +: lagging : PF2	0,001 (Signed)
50566	C586	2	Power Factor phase 3 -: leading and +: lagging : PF3	0,001 (Signed)

## Annexe II - 2. Energy

Function 3 Codes

Dec. Address	Hex. Address	Words count	Description	Unit
50770	C652	2	Total Positive Active Energy (no resetable): Ea+	kWh
50772	C654	2	Total Positive Reactive Energy (no resetable): Er +	kvarh
50774	C656	2	Total Apparent Energy (no resetable): Es	kVAh
50776	C658	2	Total Negative Active Energy (no resetable): Ea-	kWh
50778	C65A	2	Total Negative Reactive Energy (no resetable): Er -	kvarh
50780	C65C	2	Partial Positive Active Energy: Ea+	kWh
50782	C65E	2	Partial Positive Reactive Energy: Er +	kvarh
50784	C660	2	Partial Apparent Energy : Es	kVAh
50786	C662	2	Partial Negative Active Energy : Ea-	kWh

Dec. Address	Hex. Address	Words count	Description	Unit
50788	C664	2	Partial Negative Reactive Energy : Er -	kvarh

## Annexe II - 3. Metrology not affected by current and voltage transformers

Function 3 Codes

Dec. Address	Hex. Address	Words count	Description	Unit
51281	C851	1	Phase to Phase Voltage: U12 (load)	V/100
51282	C852	1	Phase to Phase Voltage: U23 (load)	V/100
51283	C853	1	Phase to Phase Voltage: U31 (load)	V/100
51284	C854	1	Simple voltage: V1 (load)	V/100
51285	C855	1	Simple voltage: V2 (load)	V/100
51286	C856	1	Simple voltage: V3 (load)	V/100
51287	C857	1	Frequency: F	Hz/100
51288	C858	1	Current: I1	mA
51289	C859	1	Current: I2	mA
51290	C85A	1	Current: I3	mA
51291	C85B	1	Neutral Current: In	mA
51292	C85C	1	$\sum$ active Power $\pm$ : P	kW/100 (Signed)
51293	C85D	1	$\sum$ reactive Power $\pm$ : Q	kvar/100 (Signed)
51294	C85E	1	$\sum$ apparent power: S	kVA/100
51295	C85F	1	$\sum$ power factor: -: leading and +: lagging: PF	0,001 (Signed)
51296	C860	1	Active Power phase 1 $\pm$ : P1	kW/100 (Signed)
51297	C861	1	Active Power phase 2 $\pm$ : P2	kW/100 (Signed)
51298	C862	1	Active Power phase 3 $\pm$ : P3	kW/100 (Signed)
51299	C863	1	Reactive Power phase 1 $\pm$ : Q1	kvar/100 (Signed)
51300	C864	1	Reactive Power phase 2 $\pm$ : Q2	kvar/100 (Signed)
51301	C865	1	Reactive Power phase 3 $\pm$ : Q3	kvar/100 (Signed)
51302	C866	1	Apparent power phase 1: S1	kVA/100
51303	C867	1	Apparent power phase 2: S2	kVA/100
51304	C868	1	Apparent power phase 3: S3	kVA/100
51305	C869	1	Power Factor phase 1 -: leading and +: lagging : PF1	0,001 (Signed)
51306	C86A	1	Power Factor phase 2 -: leading and +: lagging : PF2	0,001 (Signed)
51307	C86B	1	Power Factor phase 3 -: leading and +: lagging : PF3	0,001 (Signed)
51311	C86F	1	Total Positive Active Energy (no resetable): Ea+	MWh
51312	C870	1	Total Positive Reactive Energy (no resetable): Er +	Mvarh
51313	C871	1	Total Negative Active Energy (no resetable): Ea-	MWh
51314	C872	1	Total Negative Reactive Energy (no resetable): Er -	Mvarh

## Annexe II - 4. Input/Output state

Function 3 Codes

Dec. Address	Hex. Address	Words count	Description	Unit
51968	CB00	1	Input count	
51969	CB01	1	Bit 0: Input 1 Open or Closed Bit x: Input x +1 Open or Closed	
51970	CB02	1	Output count	
51971	CB03	1	Bit 0: Output 1 Open or Closed Bit x: Output x +1 Open or Closed	

## Annexe II - 5. Current transformer setting

Function 3, 6 and 16 Codes

Dec. Address	Hex. Address	Words count	Description	Unit
57345	E001	1	Current Transformer secondary: 1: 1 A 5: 5 A	
57346	E002	1	Current Transformer primary	A

## Annexe II - 6. Hour/Date setting

Function 3 and 16 Codes

Dec. Address	Hex. Address	Words count	Description	Unit
57600	E100	1	Day	
57601	E101	1	Month	
57602	E102	1	Year	
57603	E103	1	Hour	
57604	E104	1	Minute	
57605	E105	1	Second	

## Annexe II - 7. Ethernet module interface

Function 3, 6 and 16 Codes

Dec. Address	Hex. Address	Words count	Description	Unit
57616	E110	1	Ethernet IP address - part 1	0 - 255
57617	E111	1	Ethernet IP address - part 2	0 - 255
57618	E112	1	Ethernet IP address - part 3	0 - 255
57619	E113	1	Ethernet IP address - part 4	0 - 255
57620	E114	1	Ethernet GATE - part 1	0 - 255
57621	E115	1	Ethernet GATE - part 2	0 - 255
57622	E116	1	Ethernet GATE - part 3	0 - 255
57623	E117	1	Ethernet GATE - part 4	0 - 255
57624	E118	1	Ethernet MASK - part 1	0 - 255
57625	E119	1	Ethernet MASK - part 2	0 - 255
57626	E11A	1	Ethernet MASK - part 3	0 - 255
57627	E11B	1	Ethernet MASK - part 4	0 - 255
57628	E11C	1	DHCP used 1: yes 0: no	
57629	E11D	1	MODBUS gateway enabled 1: yes 0: no	
57630	E11E	1	MODBUS RTU over Ethernet Enabled 1: yes 0: no	
57631	E11F	1	Gateway External MODBUS Baudrate enumeration 0: 2400 bps 1: 4800 bps 2: 9600 bps 3: 19200 bps 4: 38400 bps	



Dec. Address	Hex. Address	Words count	Description	Unit
57632	E120	1	Gateway External MODBUS Parity 0: none 1: even 2: odd	
57633	E121	1	Gateway External MODBUS Stopbit 0: 1 stop bit 1: 2 stop bits	
57634	E122	1	MODBUS Gateway Master request timeout	ms
57635	E123	1	MODBUS Slave address (RS485 & RTU over Ethernet)	1-247

## Annexe II - 8. Action system

Function 6 Codes

Dec. Address	Hex. Address	Words count	Description	Unit
57856	E200	1	Action: 0xA1: Product Configuration storage 0xB2: Produit reset	

## Annexe II - 9. Status

Function 6 Codes

Dec. Address	Hex. Address	Words count	Description	Unit
20480	5000	2	Date & Time Current	-
20482	5002	1	Operating Mode 0x0000: Manual Mode 0x0001: Locked Mode 0x0010: Auto Mode 0x0020: Remote control mode 0x0040: Inhibit Mode	
20483	5003	1	Switch Position 0: Unknown 1: Position 0 2: Position I 3: Position II	
20484	5004	1	Source 2 Start Generator relay State 0: Not Active 1: Active	
20485	5005	1	Priority 0: Network 1: Source 1 2: Source 2	
20486	5006	1	Source1 State 0: Under Threshold BusBar 1: Present 2: Available	
20487	5007	1	Source2 State 0: Under Threshold BusBar 1: Present 2: Available	
20488	5008	1	Test in progress 0x0000: None 0x0001: TOF 0x0002: EOF 0x0004: TON 0x0008: EON	

Dec. Address	Hex. Address	Words count	Description	Unit
20489	5009	1	Fault summary 0: None 1: Alarm 2: Fault	
20490	500A	1	Alarm/Fault Code 0x0001: Operating factor (Alarm) 0x0002: Neutral position (Alarm) 0x0004: External fault 1 (Fault) 0x0008: External fault 2 (Fault) 0x0010: Alarm 1 (Alarm) 0x0020: Alarm 2 (Alarm) 0x0040: Source 1 rotation (Alarm) 0x0080: Source 2 rotation (Alarm) 0x0100: Source 1 unbalanced 1 (Alarm) 0x0200: Source 2 unbalanced 2 (Alarm) 0x0400: Position 0 (Fault) 0x0800: Position I (Fault) 0x1000: Position II (Fault) 0x2000: Main fault (Fault) 0x4000: Motor fault (Fault) 0x8000: Autoconfiguration failed (Alarm)	
20491	500B	1	Last Switch over cause 0: None 1: Manual 2: Remote controlled 3: Under voltage source 1 4: Under voltage source 2 5: Over voltage source 1 6: Over voltage source 2 7: Under Frequency source 1 8: Under Frequency source 2 9: Over Frequency source 1 10: Over Frequency source 2 11: Unbalance Source 1 12: Unbalance Source 2 13: Rotation Source 1 14: Rotation Source 2	
20492	500C	2	Firmware last flash date	-
20494	500E	2	Date of first commissioning	-
20496	5010	8	Product identification	-
20504	5018	1	Power supply status 0: No network present for DPS 1: Source 1 present for DPS 2: Source 2 present for DPS 3: Sources 1+2 present for DPS	
20505	5019	1	Source 1: Phase 1 presence 1: Present 0: Absent	
20506	501A	1	Source 1: Phase 2 presence 1: Present 0: Absent	
20507	501B	1	Source 1: Phase 3 presence 1: Present 0: Absent	
20508	501C	1	Source 2: Phase 1 presence 1: Present 0: Absent	
20509	501D	1	Source 2: Phase 2 presence 1: Present 0: Absent	
20510	501E	1	Source 2: Phase 3 presence 1: Present 0: Absent	

Dec. Address	Hex. Address	Words count	Description	Unit
20511	501F	1	BET Mode 0: Not present 1: Auto 2: Manual 3: Remote control 4: Locked	
20512	5020	1	BET Available 0: Not available 1: Available	
20513	5021	1	Product is available 0: Not available 1: Available	

## Annexe II - 10. Engine exerciser - custom time range status

Function 3 Codes

Dec. Address	Hex. Address	Words count	Description	Unit
20560	5050	2	Date & Time current	sec.
20562	5052	1	Next custom range to be activated 0: None 1: Custom 1 2: Custom 2 3: Custom 3 4: Custom 4	
20563	5053	2	Next custom range start date	sec.
20565	5055	2	Next custom range stop date	sec.
20567	5057	2	Next custom range start delay	sec.

## Annexe II - 11. Measurement table (no CT/VT affected)

Function 3 Codes

Dec. Address	Hex. Address	Words count	Description	Unit
20736	5100	2	Date & Time current	sec.

Down Stream Voltage				
20738	5102	1	U12	V/100
20739	5103	1	U23	V/100
20740	5104	1	U31	V/100
20741	5105	1	V1	V/100
20742	5106	1	V2	V/100
20743	5107	1	V3	V/100
20744	5108	1	Fr	Hz/100

Up Stream Voltage				
20745	5109	1	Source 1: U12	V/100
20746	510A	1	Source 1: U23	V/100
20747	510B	1	Source 1: U31	V/100
20748	510C	1	Source 1: V1	V/100
20749	510D	1	Source 1: V2	V/100
20750	510E	1	Source 1: V3	V/100

Up Stream Voltage				
20751	510F	1	Source 1: F	Hz/100
20752	5110	1	Source 2: U12	V/100
20753	5111	1	Source 2: U23	V/100
20754	5112	1	Source 2: U31	V/100
20755	5113	1	Source 2: V1	V/100
20756	5114	1	Source 2: V2	V/100
20757	5115	1	Source 2: V3	V/100
20758	5116	1	Source 2: F	Hz/100

Down Stream Current				
20759	5117	1	I1	mA
20760	5118	1	I2	mA
20761	5119	1	I3	mA
20762	511A	1	Ineutral	mA

Power				
20763	511B	2	Active Power phase 1	W / 100
20765	511D	2	Active Power phase 2	W / 100
20767	511F	2	Active Power phase 3	W / 100
20769	5121	2	Reactive Power phase 1	var / 100
20771	5123	2	Reactive Power phase 2	var / 100
20773	5125	2	Reactive Power phase 3	var / 100
20775	5127	2	Apparent power phase 1	VA / 100
20777	5129	2	Apparent power phase 2	VA / 100
20779	512B	2	Apparent power phase 3	VA / 100
20781	512D	1	Power Factor phase 1 (-: leading and +: lagging)	% / 100
20782	512E	1	Power Factor phase 2 (-: leading and +: lagging)	% / 100
20783	512F	1	Power Factor phase 3 (-: leading and +: lagging)	% / 100
20784	5130	2	Total Active Power	W / 100
20786	5132	2	Total Reactive Power	var / 100
20788	5134	2	Total Apparent Power	VA / 100
20790	5136	1	Total Power Factor (-: leading and +: lagging)	% / 100

Up Stream Status				
20791	5137	1	Neutral position 0: Left 1: Right	
20792	5138	1	Source 1: Single voltage unbalance	% / 100
20793	5139	1	Source 1: Phases rotation 0: N/A 1: ABC 2: ACB	
20794	513A	1	Source 2: Single voltage unbalance	% / 100
20795	513B	1	Source 2: Phases rotation 0: N/A 1: ABC 2: ACB	

## Annexe II - 12. Energies and time meters

### Function 3 Codes

Dec. Address	Hex. Address	Words count	Description	Unit
20992	5200	2	Date & Time current	sec.

Energies meters				
20994	5202	2	Total Positive Active Energy (Ea+) source 1	kWh
20996	5204	2	Total Positive Reactive Energy (Er+) source 1	kVARh
20998	5206	2	Total Apparent Energy (Es) source 1	kVAh
21000	5208	2	Total Negative Active Energy (Ea-) source 1	kWh
21002	520A	2	Total Negative Reactive Energy (Er-) source 1	kVARh
21004	520C	2	User Partial Positive Active Energy (Ea+) source 1	kWh
21006	520E	2	User Partial Positive Reactive Energy (Er+) source 1	kVARh
21008	5210	2	User Partial Apparent Energy (Es) source 1	kVAh
21010	5212	2	User Partial Negative Active Energy (Ea-) source 1	kWh
21012	5214	2	User Partial Negative Reactive Energy (Er-) source 1	kVARh
21014	5216	2	Since Last Commutation Positive Active Energy (Ea+) source 1	kWh
21016	5218	2	Since Last Commutation Positive Reactive Energy (Er+) source 1	kVARh
21018	521A	2	Since Last Commutation Apparent Energy (Es) source 1	kVAh
21020	521C	2	Since Last Commutation Negative Active Energy (Ea-) source 1	kWh
21022	521E	2	Since Last Commutation Negative Reactive Energy (Er-) source 1	kVARh
21024	5220	2	Total Positive Active Energy (Ea+) source 2	kWh
21026	5222	2	Total Positive Reactive Energy (Er+) source 2	kVARh
21028	5224	2	Total Apparent Energy (Es) source 2	kVAh
21030	5226	2	Total Negative Active Energy (Ea-) source 2	kWh
21032	5228	2	Total Negative Reactive Energy (Er-) source 2	kVARh
21034	522A	2	User Partial Positive Active Energy (Ea+) source 2	kWh
21036	522C	2	User Partial Positive Reactive Energy (Er+) source 2	kVARh
21038	522E	2	User Partial Apparent Energy (Es) source 2	kVAh
21040	5230	2	User Partial Negative Active Energy (Ea-) source 2	kWh
21042	5232	2	User Partial Negative Reactive Energy (Er-) source 2	kVARh
21044	5234	2	Since Last Commutation Positive Active Energy (Ea+) source 2	kWh
21046	5236	2	Since Last Commutation Positive Reactive Energy (Er+) source 2	kVARh
21048	5238	2	Since Last Commutation Apparent Energy (Es) source 2	kVAh
21050	523A	2	Since Last Commutation Negative Active Energy (Ea-) source 2	kWh
21052	523C	2	Since Last Commutation Negative Reactive Energy (Er-) source 2	kVARh

Time meters				
21054	523E	2	Total time on source 1	sec.
21056	5240	2	User partial time on source 1	sec.
21058	5242	2	Since last commutation time on source 1	sec.
21060	5244	2	Total time on source 2	sec.
21062	5246	2	User partial time on source 2	sec.
21064	5248	2	Since last commutation time on source 2	sec.

## Annexe II - 13. Timers state

### Function 3 Codes

Dec. Address	Hex. Address	Words count	Description	Unit
21248	5300	2	Date & Time Current	sec.
21250	5302	1	Source 1: SFT Timer / 1FT	sec.
21251	5303	1	Source 1: SAT Timer / 1RT	sec.
21253	5305	1	Source 2: SFT Timer / 2FT	sec.
21254	5306	1	Source 2: SAT Timer / 2RT Or 2AT	sec.
21255	5307	1	Source 2: LAT Timer / 2CT	sec.
21257	5309	1	Source 2: FST Timer / 2ST	sec.
21258	530A	1	DBT Timer / ODT	sec.
21259	530B	1	LoadShedding Timer (duration) / LST	sec.
21260	530C	1	TON is unlimited 0: limited 1: unlimited	
21261	530D	1	TON (Test On Load Duration) Timer	sec.
21262	530E	1	T3T (Test on load end timer) Timer	sec.
21263	530F	1	TOF is unlimited 0: limited 1: unlimited	
21264	5310	1	TOF (Test Off Load Duration) Timer	sec.
21265	5311	1	STOLT (Time before Ord. Ext On Load) Timer / E1T	sec.
21266	5312	1	ETOLT (Time after Ord. Ext On Load) Timer / E3T	sec.
21267	5313	1	EOLTOT / E2T is unlimited 0: limited 1: unlimited	
21268	5314	1	EOLTOT (Ord. Ext On Load Duration) Timer / E2T	sec.
21269	5315	1	STOFT (Time before Ord. Ext Off Load) Timer / E5T	sec.
21270	5316	1	ETOFT (Time after Ord. Ext Off Load) Timer / E7T	sec.
21271	5317	1	EOFTOF / E6T is unlimited 0: limited 1: unlimited	
21272	5318	1	EOFTOF (Ord. Ext Off Load Duration) Timer / E6T	sec.
21273	5319	1	EET2: Secondary Source engine exerciser timeout / EET	hours
21274	531A	1	EDT2: Secondary Source engine exerciser duration / EDT	sec.
21275	531B	1	Source 1: SFT Timer / 1FT state 1: Active 0: Not active	
21276	531C	1	Source 1: SAT Timer / 1RT state 1: Active 0: Not active	
21277	531D	1	Source 1: ORT Timer / 1OT state 1: Active 0: Not active	
21278	531E	1	Source 2: SFT Timer / 2FT state 1: Active 0: Not active	
21279	531F	1	Source 2: SAT Timer / 2RT Or 2AT state 1: Active 0: Not active	

Dec. Address	Hex. Address	Words count	Description	Unit
21280	5320	1	Source 2: LAT Timer / 2CT state 1: Active 0: Not active	
21281	5321	1	Source 2: ORT Timer / 2OT state 1: Active 0: Not active	
21282	5322	1	Source 2: FST Timer / 2ST state 1: Active 0: Not active	
21283	5323	1	DBT Timer / ODT state 1: Active 0: Not active	
21284	5324	1	LoadShedding Timer (duration) / LST state 1: Active 0: Not active	
21285	5325	1	TON (Test On Load Duration) Timer state 1: Active 0: Not active	
21286	5326	1	T3T (Test on load end timer) Timer state 1: Active 0: Not active	
21287	5327	1	TOF (Test Off Load Duration) Timer state 1: Active 0: Not active	
21288	5328	1	STOLT (Time before Ord. Ext On Load) Timer / E1T state 1: Active 0: Not active	
21289	5329	1	ETOLT (Time after Ord. Ext On Load) Timer / E3T state 1: Active 0: Not active	
21290	532A	1	EOLTOT (Ord. Ext On Load Duration) Timer / E2T state 1: Active 0: Not active	
21291	532B	1	STOFT (Time before Ord. Ext Off Load) Timer / E5T state 1: Active 0: Not active	
21292	532C	1	ETOFT (Time after Ord. Ext Off Load) Timer / E7T state 1: Active 0: Not active	
21293	532D	1	EOFTOF (Ord. Ext Off Load Duration) Timer / E6T state 1: Active 0: Not active	
21294	532E	1	EET2: Secondary Source engine exerciser timeout / EET state 1: Active 0: Not active	
21295	532F	1	EDT2: Secondary Source engine exerciser duration / EDT state 1: Active 0: Not active	

## Annexe II - 14. Option module state

### Function 3 Codes

Dec. Address	Hex. Address	Words count	Description	Unit
21504	5400	2	Date & Time Current	sec.

Dec. Address	Hex. Address	Words count	Description	Unit
21506	5402	1	Option slot 1 Type 0xFF: None 0x00: Communication option 0x01: Metering option 0x20: Input/Output option 0x30: Analog Outputs option 0x70: Ethernet option	
21507	5403	1	Option slot 2 Type 0xFF: None 0x00: Communication option 0x01: Metering option 0x20: Input/Output option 0x30: Analog Outputs option 0x70: Ethernet option	
21508	5404	1	Option slot 3 Type 0xFF: None 0x00: Communication option 0x01: Metering option 0x20: Input/Output option 0x30: Analog Outputs option 0x70: Ethernet option	
21509	5405	1	Option slot 4 Type 0xFF: None 0x00: Communication option 0x01: Metering option 0x20: Input/Output option 0x30: Analog Outputs option 0x70: Ethernet option	

## Annexe II - 15. Commands

### Function 6 Codes

Dec. Address	Hex. Address	Words count	Description	Unit
21760	5500	1	Set Command / Alarm 0x01: Set RTE 0x02: Clear TOF 0x03: Set TOF 0x04: Set TON 0x05: Set EOF 0x06: Set EON 0x07: Clear EOF 0x08: Clear EON 0x10: Clear Alarms/Faults 0x11: Set External Fault 1 0x12: Set External Fault 2 0x13: Set External Alarm 1 0x14: Set External Alarm 2	
21761	5501	1	Set Operating Mode 3: Auto 4: Inhibit 5: Remote Control	
21762	5502	1	Set Priority 0: Network 1: Source 1 2: Source 2	
21763	5503	1	Set Position 0: None 1: Position in Zero 2: Position in 1 3: Position in 2	



## Annexe II - 16. User commands

Function 6 Codes

Dec. Address	Hex. Address	Words count	Description	Unit
21840	5550	1	Auto configuration request <i>1: make autoconfig</i>	
21841	5551	1	Settings backup <i>1: save current settings as user defaults</i> <i>2: restore user defaults settings</i> <i>3: restore factory settings</i>	
21842	5552	1	Source 1 partial counters erase <i>0x01: Ea+</i> <i>0x02: Er+</i> <i>0x04: Es</i> <i>0x08: Ea-</i> <i>0x10: Er-</i> <i>0x20: Hour counter</i>	
21843	5553	1	Source 2 partial counters erase <i>0x01: Ea+</i> <i>0x02: Er+</i> <i>0x04: Es</i> <i>0x08: Ea-</i> <i>0x10: Er-</i> <i>0x20: Hour counter</i>	
21844	5554	1	Product user counters erase <i>0x01: Genset start counter erase</i> <i>0x02: Genset runtime counter erase</i> <i>0x04: Secondary source presence counter erase</i> <i>0x08: Secondary source active duration counter erase</i> <i>0x10: Source 1 load supplied duration counter erase</i> <i>0x20: Source 2 load supplied duration counter erase</i>	

## Annexe II - 17. Setup timer

Function 3, 6 and 16 Codes

Dec. Address	Hex. Address	Words count	Description	Unit
<b>Source 1 timers</b>				
22016	5600	1	1FT: Primary Source fail timer	sec.
22017	5601	1	1RT: Primary Source availability/stabilization timer	sec.

<b>Source 2 timers</b>				
22023	5607	1	2FT: Secondary Source fail timer	sec.
22024	5608	1	2RT/2AT: Secondary Source availability/stabilization timer	sec.
22025	5609	1	2CT: Secondary Source maintain request timer (cooldown timer)	sec.
22027	560B	1	2ST: Secondary Source wait for start timer	sec.
22028	560C	1	EET: Secondary Source engine exerciser timeout	hours
22029	560D	1	EDT: Secondary Source engine exerciser duration	sec.

<b>General timers</b>				
22030	560E	1	ODT: Dead band timer	sec.
22031	560F	1	Limit_TON: Test on load is limited <i>0: unlimited</i> <i>1: limited</i>	
22032	5610	1	TOT: Test on load duration timer	sec.

General timers				
22033	5611	1	T3T: Test on load end timer	sec.
22034	5612	1	Limit_TOF: Test off load is limited 0: unlimited 1: limited	
22035	5613	1	TFT: Test off load duration timer	sec.
22036	5614	1	E1T: Time before external order on load	sec.
22037	5615	1	E3T: Time after external order on load	sec.
22038	5616	1	Limit_EOLTOT: External order on load is limited 0: unlimited 1: limited	
22039	5617	1	E2T: External order on load duration	sec.
22040	5618	1	E5T: Time before external order off load	sec.
22041	5619	1	E7T: Time after external order off load	sec.
22042	561A	1	Limit_EOFTOF: External order off load is limited 0: unlimited 1: limited	
22043	561B	1	E7T: External order off load duration	sec.

## Annexe II - 18. Setup threshold for upstream Voltages

Function 3, 6 and 16 Codes

Dec. Address	Hex. Address	Words count	Description	Unit
22272	5700	1	Source 1: Overvoltage threshold	%
22273	5701	1	Source 1: Overvoltage hysteresis threshold	%
22274	5702	1	Source 1: Undervoltage threshold	%
22275	5703	1	Source 1: Undervoltage hysteresis threshold	%
22276	5704	1	Source 2: Overvoltage threshold	%
22277	5705	1	Source 2: Overvoltage hysteresis threshold	%
22278	5706	1	Source 2: Undervoltage threshold	%
22279	5707	1	Source 2: Undervoltage hysteresis threshold	%
22280	5708	1	Source 1: Unbalanced voltage threshold	%
22281	5709	1	Source 1: Unbalanced voltage hysteresis threshold	%
22282	570A	1	Source 2: Unbalanced voltage threshold	%
22283	570B	1	Source 2: Unbalanced voltage hysteresis threshold	%
22284	570C	1	Source 1: Overfrequency threshold	%
22285	570D	1	Source 1: Overfrequency hysteresis threshold	%
22286	570E	1	Source 1: Underfrequency threshold	%
22287	570F	1	Source 1: Underfrequency hysteresis threshold	%
22288	5710	1	Source 2: Overfrequency threshold	%
22289	5711	1	Source 2: Overfrequency hysteresis threshold	%
22290	5712	1	Source 2: Underfrequency threshold	%
22291	5713	1	Source 2: Underfrequency hysteresis threshold	%

## Annexe II - 19. Setup user's power threshold

Function 3, 6 and 16 Codes

Dec. Address	Hex. Address	Words count	Description	Unit
<b>Source 1 user thresholds</b>				
22528	5800	1	Source 1: Total Apparent Power threshold	kVA
22529	5801	1	Source 1: Total Apparent Power hysteresis threshold	kVA
<b>Source 2 user thresholds</b>				
22530	5802	1	Source 2: Total Apparent Power threshold	kVA
22531	5803	1	Source 2: Total Apparent Power hysteresis threshold	kVA

## Annexe II - 20. Setup network

Function 3, 6 and 16 Codes

Dec. Address	Hex. Address	Words count	Description	Unit
22784	5900	1	Network Type 0: 1BL 1: 2NBL 2: 2BL 3: 3NBL 4: 3BL 5: 4NBL 6: 4BL 7: 41NBL 8: 42NBL	
22785	5901	1	Neutral 0: LEFT 1: RIGHT 2: AUTO	
22786	5902	1	Phase rotation 0: Verify Compatible ("Auto") 1: Verify ABC 2: Verify ACB	
22787	5903	1	Unom	V
22788	5904	1	Fnom 0: 50Hz 1: 60Hz	
22789	5905	1	Type Application 0: Main - Main 1: Main - Gen	
22790	5906	1	Generator start order inhibit 0: NO 1: YES	
22792	5908	1	Source priority 0: Network 1: Source1 2: Source2	
22793	5909	1	Test On Load priority 0: NO 1: YES	
22794	590A	1	External Order On Load priority 0: NO 1: YES	

Dec. Address	Hex. Address	Words count	Description	Unit
22795	590B	1	Manual retransfer 0: NO 1: YES	
22799	590F	1	BackLight 0: ON 1: OFF 2: INT	
22800	5910	1	Current transformer (Pri)	-
22801	5911	1	Current transformer (Sec) 1: TCsec = 1 A 5: TCsec = 2 A	
22802	5912	1	Invert Source 1 and Source 2 0: Not inverted 1: Inverted	

## Annexe II - 21. Setup Input/Output

Function 3, 6 and 16 Codes

Dec. Address	Hex. Address	Words count	Description	Unit
23040	5A00	1	In 5 - StartGen board input 1 function 0: --- - None 1: INH - Inhibition 2: TON - Test on load 3: TOF - Test off load 4: EON - External order on load 5: EOF - External order off load 6: RTC - Retransfer 7: PRI - Priority 8: SS1 - Validation Stabilization source 1 9: SS2 - Validation Stabilization source 2 10: AL1 - Alarm 1 11: AL2 - Alarm 2 12: FT1 - Fault 1 13: FT2 - Fault 2 14: MSR - Power priority 15: OA1 - Override source 1 available 16: OA2 - Override source 2 available 17: RST - Reset faults state 18: LSI - Load shedding 19: TR1 - Time Range1 Validate 20: TR2 - Time Range2 Validate 21: TR3 - Time Range3 Validate 22: TR4 - Time Range4 Validate 24: CHP - Change of position	

Dec. Address	Hex. Address	Words count	Description	Unit
23041	5A01	1	In 6 - StartGen board input 2 function 0: --- - None 1: INH - Inhibition 2: TON - Test on load 3: TOF - Test off load 4: EON - External order on load 5: EOF - External order off load 6: RTC - Retransfer 7: PRI - Priority 8: SS1 - Validation Stabilization source 1 9: SS2 - Validation Stabilization source 2 10: AL1 - Alarm 1 11: AL2 - Alarm 2 12: FT1 - Fault 1 13: FT2 - Fault 2 14: MSR - Power priority 15: OA1 - Override source 1 available 16: OA2 - Override source 2 available 17: RST - Reset faults state 18: LSI - Load shedding 19: TR1 - Time Range1 Validate 20: TR2 - Time Range2 Validate 21: TR3 - Time Range3 Validate 22: TR4 - Time Range4 Validate 24: CHP - Change of position	
23042	5A02	1	In 5 - Input n°5 state 0: NO 1: NC	
23043	5A03	1	In 6 - Input n°6 state 0: NO 1: NC	
23044	5A04	1	In 1 - Ext display connector board input 1 function 0: --- - None 1: INH - Inhibition 2: TON - Test on load 3: TOF - Test off load 4: EON - External order on load 5: EOF - External order off load 6: RTC - Retransfer 7: PRI - Priority 8: SS1 - Validation Stabilization source 1 9: SS2 - Validation Stabilization source 2 10: AL1 - Alarm 1 11: AL2 - Alarm 2 12: FT1 - Fault 1 13: FT2 - Fault 2 14: MSR - Power priority 15: OA1 - Override source 1 available 16: OA2 - Override source 2 available 17: RST - Reset faults state 18: LSI - Load shedding 19: TR1 - Time Range1 Validate 20: TR2 - Time Range2 Validate 21: TR3 - Time Range3 Validate 22: TR4 - Time Range4 Validate 24: CHP - Change of position	

Dec. Address	Hex. Address	Words count	Description	Unit
23045	5A05	1	<p>In 2 - Ext display connector board input 2 function</p> <p>0: --- - None</p> <p>1: INH - Inhibition</p> <p>2: TON - Test on load</p> <p>3: TOF - Test off load</p> <p>4: EON - External order on load</p> <p>5: EOF - External order off load</p> <p>6: RTC - Retransfer</p> <p>7: PRI - Priority</p> <p>8: SS1 - Validation Stabilization source 1</p> <p>9: SS2 - Validation Stabilization source 2</p> <p>10: AL1 - Alarm 1</p> <p>11: AL2 - Alarm 2</p> <p>12: FT1 - Fault 1</p> <p>13: FT2 - Fault 2</p> <p>14: MSR - Power priority</p> <p>15: OA1 - Override source 1 available</p> <p>16: OA2 - Override source 2 available</p> <p>17: RST - Reset faults state</p> <p>18: LSI - Load shedding</p> <p>19: TR1 - Time Range1 Validate</p> <p>20: TR2 - Time Range2 Validate</p> <p>21: TR3 - Time Range3 Validate</p> <p>22: TR4 - Time Range4 Validate</p> <p>24: CHP - Change of position</p>	
23046	5A06	1	<p>In 3 - Ext display connector board input 3 function</p> <p>0: --- - None</p> <p>1: INH - Inhibition</p> <p>2: TON - Test on load</p> <p>3: TOF - Test off load</p> <p>4: EON - External order on load</p> <p>5: EOF - External order off load</p> <p>6: RTC - Retransfer</p> <p>7: PRI - Priority</p> <p>8: SS1 - Validation Stabilization source 1</p> <p>9: SS2 - Validation Stabilization source 2</p> <p>10: AL1 - Alarm 1</p> <p>11: AL2 - Alarm 2</p> <p>12: FT1 - Fault 1</p> <p>13: FT2 - Fault 2</p> <p>14: MSR - Power priority</p> <p>15: OA1 - Override source 1 available</p> <p>16: OA2 - Override source 2 available</p> <p>17: RST - Reset faults state</p> <p>18: LSI - Load shedding</p> <p>19: TR1 - Time Range1 Validate</p> <p>20: TR2 - Time Range2 Validate</p> <p>21: TR3 - Time Range3 Validate</p> <p>22: TR4 - Time Range4 Validate</p> <p>24: CHP - Change of position</p>	

Dec. Address	Hex. Address	Words count	Description	Unit
23047	5A07	1	In 4 - Ext display connector board input 4 function 0: --- - None 1: INH - Inhibition 2: TON - Test on load 3: TOF - Test off load 4: EON - External order on load 5: EOF - External order off load 6: RTC - Retransfer 7: PRI - Priority 8: SS1 - Validation Stabilization source 1 9: SS2 - Validation Stabilization source 2 10: AL1 - Alarm 1 11: AL2 - Alarm 2 12: FT1 - Fault 1 13: FT2 - Fault 2 14: MSR - Power priority 15: OA1 - Override source 1 available 16: OA2 - Override source 2 available 17: RST - Reset faults state 18: LSI - Load shedding 19: TR1 - Time Range1 Validate 20: TR2 - Time Range2 Validate 21: TR3 - Time Range3 Validate 22: TR4 - Time Range4 Validate 24: CHP - Change of position	
23048	5A08	1	In 1 - Input n°1 state 0: NO 1: NC	
23049	5A09	1	In 2 - Input n°2 state 0: NO 1: NC	
23050	5A0A	1	In 3 - Input n°3 state 0: NO 1: NC	
23051	5A0B	1	In 4 - Input n°4 state 0: NO 1: NC	
23052	5A0C	1	In 7 function (only with 2IN2OUT module #1) 0: --- - None 1: INH - Inhibition 2: TON - Test on load 3: TOF - Test off load 4: EON - External order on load 5: EOF - External order off load 6: RTC - Retransfer 7: PRI - Priority 8: SS1 - Validation Stabilization source 1 9: SS2 - Validation Stabilization source 2 10: AL1 - Alarm 1 11: AL2 - Alarm 2 12: FT1 - Fault 1 13: FT2 - Fault 2 14: MSR - Power priority 15: OA1 - Override source 1 available 16: OA2 - Override source 2 available 17: RST - Reset faults state 18: LSI - Load shedding 19: TR1 - Time Range1 Validate 20: TR2 - Time Range2 Validate 21: TR3 - Time Range3 Validate 22: TR4 - Time Range4 Validate 24: CHP - Change of position	

<b>Dec. Address</b>	<b>Hex. Address</b>	<b>Words count</b>	<b>Description</b>	<b>Unit</b>
23053	5A0D	1	<p>In 8 function (only with 2IN2OUT module #1)</p> <p>0: --- - None</p> <p>1: INH - Inhibition</p> <p>2: TON - Test on load</p> <p>3: TOF - Test off load</p> <p>4: EON - External order on load</p> <p>5: EOF - External order off load</p> <p>6: RTC - Retransfer</p> <p>7: PRI - Priority</p> <p>8: SS1 - Validation Stabilization source 1</p> <p>9: SS2 - Validation Stabilization source 2</p> <p>10: AL1 - Alarm 1</p> <p>11: AL2 - Alarm 2</p> <p>12: FT1 - Fault 1</p> <p>13: FT2 - Fault 2</p> <p>14: MSR - Power priority</p> <p>15: OA1 - Override source 1 available</p> <p>16: OA2 - Override source 2 available</p> <p>17: RST - Reset faults state</p> <p>18: LSI - Load shedding</p> <p>19: TR1 - Time Range1 Validate</p> <p>20: TR2 - Time Range2 Validate</p> <p>21: TR3 - Time Range3 Validate</p> <p>22: TR4 - Time Range4 Validate</p> <p>24: CHP - Change of position</p>	
23054	5A0E	1	<p>In 9 function (only with 2IN2OUT module #2)</p> <p>0: --- - None</p> <p>1: INH - Inhibition</p> <p>2: TON - Test on load</p> <p>3: TOF - Test off load</p> <p>4: EON - External order on load</p> <p>5: EOF - External order off load</p> <p>6: RTC - Retransfer</p> <p>7: PRI - Priority</p> <p>8: SS1 - Validation Stabilization source 1</p> <p>9: SS2 - Validation Stabilization source 2</p> <p>10: AL1 - Alarm 1</p> <p>11: AL2 - Alarm 2</p> <p>12: FT1 - Fault 1</p> <p>13: FT2 - Fault 2</p> <p>14: MSR - Power priority</p> <p>15: OA1 - Override source 1 available</p> <p>16: OA2 - Override source 2 available</p> <p>17: RST - Reset faults state</p> <p>18: LSI - Load shedding</p> <p>19: TR1 - Time Range1 Validate</p> <p>20: TR2 - Time Range2 Validate</p> <p>21: TR3 - Time Range3 Validate</p> <p>22: TR4 - Time Range4 Validate</p> <p>24: CHP - Change of position</p>	



Dec. Address	Hex. Address	Words count	Description	Unit
23055	5A0F	1	<p>In 10 function (only with 2IN2OUT module #2)</p> <p>0: --- - None</p> <p>1: INH - Inhibition</p> <p>2: TON - Test on load</p> <p>3: TOF - Test off load</p> <p>4: EON - External order on load</p> <p>5: EOF - External order off load</p> <p>6: RTC - Retransfer</p> <p>7: PRI - Priority</p> <p>8: SS1 - Validation Stabilization source 1</p> <p>9: SS2 - Validation Stabilization source 2</p> <p>10: AL1 - Alarm 1</p> <p>11: AL2 - Alarm 2</p> <p>12: FT1 - Fault 1</p> <p>13: FT2 - Fault 2</p> <p>14: MSR - Power priority</p> <p>15: OA1 - Override source 1 available</p> <p>16: OA2 - Override source 2 available</p> <p>17: RST - Reset faults state</p> <p>18: LSI - Load shedding</p> <p>19: TR1 - Time Range1 Validate</p> <p>20: TR2 - Time Range2 Validate</p> <p>21: TR3 - Time Range3 Validate</p> <p>22: TR4 - Time Range4 Validate</p> <p>24: CHP - Change of position</p>	
23056	5A10	1	<p>In 11 function (only with 2IN2OUT module #3)</p> <p>0: --- - None</p> <p>1: INH - Inhibition</p> <p>2: TON - Test on load</p> <p>3: TOF - Test off load</p> <p>4: EON - External order on load</p> <p>5: EOF - External order off load</p> <p>6: RTC - Retransfer</p> <p>7: PRI - Priority</p> <p>8: SS1 - Validation Stabilization source 1</p> <p>9: SS2 - Validation Stabilization source 2</p> <p>10: AL1 - Alarm 1</p> <p>11: AL2 - Alarm 2</p> <p>12: FT1 - Fault 1</p> <p>13: FT2 - Fault 2</p> <p>14: MSR - Power priority</p> <p>15: OA1 - Override source 1 available</p> <p>16: OA2 - Override source 2 available</p> <p>17: RST - Reset faults state</p> <p>18: LSI - Load shedding</p> <p>19: TR1 - Time Range1 Validate</p> <p>20: TR2 - Time Range2 Validate</p> <p>21: TR3 - Time Range3 Validate</p> <p>22: TR4 - Time Range4 Validate</p> <p>24: CHP - Change of position</p>	

Dec. Address	Hex. Address	Words count	Description	Unit
23057	5A11	1	<p>In 12 function (only with 2IN2OUT module #3)</p> <p>0: --- - None</p> <p>1: INH - Inhibition</p> <p>2: TON - Test on load</p> <p>3: TOF - Test off load</p> <p>4: EON - External order on load</p> <p>5: EOF - External order off load</p> <p>6: RTC - Retransfer</p> <p>7: PRI - Priority</p> <p>8: SS1 - Validation Stabilization source 1</p> <p>9: SS2 - Validation Stabilization source 2</p> <p>10: AL1 - Alarm 1</p> <p>11: AL2 - Alarm 2</p> <p>12: FT1 - Fault 1</p> <p>13: FT2 - Fault 2</p> <p>14: MSR - Power priority</p> <p>15: OA1 - Override source 1 available</p> <p>16: OA2 - Override source 2 available</p> <p>17: RST - Reset faults state</p> <p>18: LSI - Load shedding</p> <p>19: TR1 - Time Range1 Validate</p> <p>20: TR2 - Time Range2 Validate</p> <p>21: TR3 - Time Range3 Validate</p> <p>22: TR4 - Time Range4 Validate</p> <p>24: CHP - Change of position</p>	
23058	5A12	1	<p>In 13 function (only with 2IN2OUT module #4)</p> <p>0: --- - None</p> <p>1: INH - Inhibition</p> <p>2: TON - Test on load</p> <p>3: TOF - Test off load</p> <p>4: EON - External order on load</p> <p>5: EOF - External order off load</p> <p>6: RTC - Retransfer</p> <p>7: PRI - Priority</p> <p>8: SS1 - Validation Stabilization source 1</p> <p>9: SS2 - Validation Stabilization source 2</p> <p>10: AL1 - Alarm 1</p> <p>11: AL2 - Alarm 2</p> <p>12: FT1 - Fault 1</p> <p>13: FT2 - Fault 2</p> <p>14: MSR - Power priority</p> <p>15: OA1 - Override source 1 available</p> <p>16: OA2 - Override source 2 available</p> <p>17: RST - Reset faults state</p> <p>18: LSI - Load shedding</p> <p>19: TR1 - Time Range1 Validate</p> <p>20: TR2 - Time Range2 Validate</p> <p>21: TR3 - Time Range3 Validate</p> <p>22: TR4 - Time Range4 Validate</p> <p>24: CHP - Change of position</p>	

Dec. Address	Hex. Address	Words count	Description	Unit
23059	5A13	1	In 14 function (only with 2IN2OUT module #4) 0: --- - None 1: INH - Inhibition 2: TON - Test on load 3: TOF - Test off load 4: EON - External order on load 5: EOF - External order off load 6: RTC - Retransfer 7: PRI - Priority 8: SS1 - Validation Stabilization source 1 9: SS2 - Validation Stabilization source 2 10: AL1 - Alarm 1 11: AL2 - Alarm 2 12: FT1 - Fault 1 13: FT2 - Fault 2 14: MSR - Power priority 15: OA1 - Override source 1 available 16: OA2 - Override source 2 available 17: RST - Reset faults state 18: LSI - Load shedding 19: TR1 - Time Range1 Validate 20: TR2 - Time Range2 Validate 21: TR3 - Time Range3 Validate 22: TR4 - Time Range4 Validate 24: CHP - Change of position	
23060	5A14	1	In 7 state (only with 2IN2OUT module #1) 0: NO 1: NC	
23061	5A15	1	In 8 state (only with 2IN2OUT module #1) 0: NO 1: NC	
23062	5A16	1	In 9 state (only with 2IN2OUT module #2) 0: NO 1: NC	
23063	5A17	1	In 10 state (only with 2IN2OUT module #2) 0: NO 1: NC	
23064	5A18	1	In 11 state (only with 2IN2OUT module #3) 0: NO 1: NC	
23065	5A19	1	In 12 state (only with 2IN2OUT module #3) 0: NO 1: NC	
23066	5A1A	1	In 13 state (only with 2IN2OUT module #4) 0: NO 1: NC	
23067	5A1B	1	In 14 state (only with 2IN2OUT module #4) 0: NO 1: NC	

Dec. Address	Hex. Address	Words count	Description	Unit
23068	5A1C	1	Out 1 Ext display connector board relay output function 0: --- - None 1: S1A - Source 1 available 2: S2A - Source 2 available 3: SCA - Any source available 4: CA1 - Source 1 closed 5: CA2 - Source 2 closed 6: CA0 - Both sources opened 7: LO1 - Source 1 closed and available 8: LO2 - Source 2 closed and available 9: LSC - Load shedding 10: FLT - Faults active 11: POP - Product operational 12: C01 - In 1 copy 13: C02 - In 2 copy 14: C03 - In 3 copy 15: C04 - In 4 copy 16: C05 - In 5 copy 17: C06 - In 6 copy 18: C07 - In 7 copy 19: C08 - In 8 copy 20: C09 - In 9 copy 21: C10 - In 10 copy 22: C11 - In 11 copy 23: C12 - In 12 copy 24: C13 - In 13 copy 25: C14 - In 14 copy 26: LCK - Product locked 27: PTS - Power threshold exceeded 28: EES - Battery charger 29: COM - Set by Modbus 30: COP - Controller available 31: MAN - Product in manual mode	
23069	5A1D	1	Out 1 Ext display connector board relay output state 0: NO 1: NC	

Dec. Address	Hex. Address	Words count	Description	Unit
23070	5A1E	1	<p>Out 2 function (only with 2IN2OUT module #1)</p> <p>0: --- - None</p> <p>1: S1A - Source 1 available</p> <p>2: S2A - Source 2 available</p> <p>3: SCA - Any source available</p> <p>4: CA1 - Source 1 closed</p> <p>5: CA2 - Source 2 closed</p> <p>6: CA0 - Both sources opened</p> <p>7: LO1 - Source 1 closed and available</p> <p>8: LO2 - Source 2 closed and available</p> <p>9: LSC - Load shedding</p> <p>10: FLT - Faults active</p> <p>11: POP - Product operational</p> <p>12: C01 - In 1 copy</p> <p>13: C02 - In 2 copy</p> <p>14: C03 - In 3 copy</p> <p>15: C04 - In 4 copy</p> <p>16: C05 - In 5 copy</p> <p>17: C06 - In 6 copy</p> <p>18: C07 - In 7 copy</p> <p>19: C08 - In 8 copy</p> <p>20: C09 - In 9 copy</p> <p>21: C10 - In 10 copy</p> <p>22: C11 - In 11 copy</p> <p>23: C12 - In 12 copy</p> <p>24: C13 - In 13 copy</p> <p>25: C14 - In 14 copy</p> <p>26: LCK - Product locked</p> <p>27: PTS - Power threshold exceeded</p> <p>28: EES - Battery charger</p> <p>29: COM - Set by Modbus</p> <p>30: COP - Controller available</p> <p>31: MAN - Product in manual mode</p>	
23071	5A1F	1	<p>Out 3 function (only with 2IN2OUT module #1)</p> <p>0: --- - None</p> <p>1: S1A - Source 1 available</p> <p>2: S2A - Source 2 available</p> <p>3: SCA - Any source available</p> <p>4: CA1 - Source 1 closed</p> <p>5: CA2 - Source 2 closed</p> <p>6: CA0 - Both sources opened</p> <p>7: LO1 - Source 1 closed and available</p> <p>8: LO2 - Source 2 closed and available</p> <p>9: LSC - Load shedding</p> <p>10: FLT - Faults active</p> <p>11: POP - Product operational</p> <p>12: C01 - In 1 copy</p> <p>13: C02 - In 2 copy</p> <p>14: C03 - In 3 copy</p> <p>15: C04 - In 4 copy</p> <p>16: C05 - In 5 copy</p> <p>17: C06 - In 6 copy</p> <p>18: C07 - In 7 copy</p> <p>19: C08 - In 8 copy</p> <p>20: C09 - In 9 copy</p> <p>21: C10 - In 10 copy</p> <p>22: C11 - In 11 copy</p> <p>23: C12 - In 12 copy</p> <p>24: C13 - In 13 copy</p> <p>25: C14 - In 14 copy</p> <p>26: LCK - Product locked</p> <p>27: PTS - Power threshold exceeded</p> <p>28: EES - Battery charger</p> <p>29: COM - Set by Modbus</p> <p>30: COP - Controller available</p> <p>31: MAN - Product in manual mode</p>	

Dec. Address	Hex. Address	Words count	Description	Unit
23072	5A20	1	<p>Out 4 function (only with 2IN2OUT module #2)</p> <p>0: --- - None</p> <p>1: S1A - Source 1 available</p> <p>2: S2A - Source 2 available</p> <p>3: SCA - Any source available</p> <p>4: CA1 - Source 1 closed</p> <p>5: CA2 - Source 2 closed</p> <p>6: CA0 - Both sources opened</p> <p>7: LO1 - Source 1 closed and available</p> <p>8: LO2 - Source 2 closed and available</p> <p>9: LSC - Load shedding</p> <p>10: FLT - Faults active</p> <p>11: POP - Product operational</p> <p>12: C01 - In 1 copy</p> <p>13: C02 - In 2 copy</p> <p>14: C03 - In 3 copy</p> <p>15: C04 - In 4 copy</p> <p>16: C05 - In 5 copy</p> <p>17: C06 - In 6 copy</p> <p>18: C07 - In 7 copy</p> <p>19: C08 - In 8 copy</p> <p>20: C09 - In 9 copy</p> <p>21: C10 - In 10 copy</p> <p>22: C11 - In 11 copy</p> <p>23: C12 - In 12 copy</p> <p>24: C13 - In 13 copy</p> <p>25: C14 - In 14 copy</p> <p>26: LCK - Product locked</p> <p>27: PTS - Power threshold exceeded</p> <p>28: EES - Battery charger</p> <p>29: COM - Set by Modbus</p> <p>30: COP - Controller available</p> <p>31: MAN - Product in manual mode</p>	
23073	5A21	1	<p>Out 5 function (only with 2IN2OUT module #2)</p> <p>0: --- - None</p> <p>1: S1A - Source 1 available</p> <p>2: S2A - Source 2 available</p> <p>3: SCA - Any source available</p> <p>4: CA1 - Source 1 closed</p> <p>5: CA2 - Source 2 closed</p> <p>6: CA0 - Both sources opened</p> <p>7: LO1 - Source 1 closed and available</p> <p>8: LO2 - Source 2 closed and available</p> <p>9: LSC - Load shedding</p> <p>10: FLT - Faults active</p> <p>11: POP - Product operational</p> <p>12: C01 - In 1 copy</p> <p>13: C02 - In 2 copy</p> <p>14: C03 - In 3 copy</p> <p>15: C04 - In 4 copy</p> <p>16: C05 - In 5 copy</p> <p>17: C06 - In 6 copy</p> <p>18: C07 - In 7 copy</p> <p>19: C08 - In 8 copy</p> <p>20: C09 - In 9 copy</p> <p>21: C10 - In 10 copy</p> <p>22: C11 - In 11 copy</p> <p>23: C12 - In 12 copy</p> <p>24: C13 - In 13 copy</p> <p>25: C14 - In 14 copy</p> <p>26: LCK - Product locked</p> <p>27: PTS - Power threshold exceeded</p> <p>28: EES - Battery charger</p> <p>29: COM - Set by Modbus</p> <p>30: COP - Controller available</p> <p>31: MAN - Product in manual mode</p>	

Dec. Address	Hex. Address	Words count	Description	Unit
23074	5A22	1	<p>Out 6 function (only with 2IN2OUT module #3)</p> <p>0: --- - None</p> <p>1: S1A - Source 1 available</p> <p>2: S2A - Source 2 available</p> <p>3: SCA - Any source available</p> <p>4: CA1 - Source 1 closed</p> <p>5: CA2 - Source 2 closed</p> <p>6: CA0 - Both sources opened</p> <p>7: LO1 - Source 1 closed and available</p> <p>8: LO2 - Source 2 closed and available</p> <p>9: LSC - Load shedding</p> <p>10: FLT - Faults active</p> <p>11: POP - Product operational</p> <p>12: C01 - In 1 copy</p> <p>13: C02 - In 2 copy</p> <p>14: C03 - In 3 copy</p> <p>15: C04 - In 4 copy</p> <p>16: C05 - In 5 copy</p> <p>17: C06 - In 6 copy</p> <p>18: C07 - In 7 copy</p> <p>19: C08 - In 8 copy</p> <p>20: C09 - In 9 copy</p> <p>21: C10 - In 10 copy</p> <p>22: C11 - In 11 copy</p> <p>23: C12 - In 12 copy</p> <p>24: C13 - In 13 copy</p> <p>25: C14 - In 14 copy</p> <p>26: LCK - Product locked</p> <p>27: PTS - Power threshold exceeded</p> <p>28: EES - Battery charger</p> <p>29: COM - Set by Modbus</p> <p>30: COP - Controller available</p> <p>31: MAN - Product in manual mode</p>	
23075	5A23	1	<p>Out 7 function (only with 2IN2OUT module #3)</p> <p>0: --- - None</p> <p>1: S1A - Source 1 available</p> <p>2: S2A - Source 2 available</p> <p>3: SCA - Any source available</p> <p>4: CA1 - Source 1 closed</p> <p>5: CA2 - Source 2 closed</p> <p>6: CA0 - Both sources opened</p> <p>7: LO1 - Source 1 closed and available</p> <p>8: LO2 - Source 2 closed and available</p> <p>9: LSC - Load shedding</p> <p>10: FLT - Faults active</p> <p>11: POP - Product operational</p> <p>12: C01 - In 1 copy</p> <p>13: C02 - In 2 copy</p> <p>14: C03 - In 3 copy</p> <p>15: C04 - In 4 copy</p> <p>16: C05 - In 5 copy</p> <p>17: C06 - In 6 copy</p> <p>18: C07 - In 7 copy</p> <p>19: C08 - In 8 copy</p> <p>20: C09 - In 9 copy</p> <p>21: C10 - In 10 copy</p> <p>22: C11 - In 11 copy</p> <p>23: C12 - In 12 copy</p> <p>24: C13 - In 13 copy</p> <p>25: C14 - In 14 copy</p> <p>26: LCK - Product locked</p> <p>27: PTS - Power threshold exceeded</p> <p>28: EES - Battery charger</p> <p>29: COM - Set by Modbus</p> <p>30: COP - Controller available</p> <p>31: MAN - Product in manual mode</p>	

Dec. Address	Hex. Address	Words count	Description	Unit
23076	5A24	1	<p>Out 8 function (only with 2IN2OUT module #4)</p> <p>0: --- - None</p> <p>1: S1A - Source 1 available</p> <p>2: S2A - Source 2 available</p> <p>3: SCA - Any source available</p> <p>4: CA1 - Source 1 closed</p> <p>5: CA2 - Source 2 closed</p> <p>6: CA0 - Both sources opened</p> <p>7: LO1 - Source 1 closed and available</p> <p>8: LO2 - Source 2 closed and available</p> <p>9: LSC - Load shedding</p> <p>10: FLT - Faults active</p> <p>11: POP - Product operational</p> <p>12: C01 - In 1 copy</p> <p>13: C02 - In 2 copy</p> <p>14: C03 - In 3 copy</p> <p>15: C04 - In 4 copy</p> <p>16: C05 - In 5 copy</p> <p>17: C06 - In 6 copy</p> <p>18: C07 - In 7 copy</p> <p>19: C08 - In 8 copy</p> <p>20: C09 - In 9 copy</p> <p>21: C10 - In 10 copy</p> <p>22: C11 - In 11 copy</p> <p>23: C12 - In 12 copy</p> <p>24: C13 - In 13 copy</p> <p>25: C14 - In 14 copy</p> <p>26: LCK - Product locked</p> <p>27: PTS - Power threshold exceeded</p> <p>28: EES - Battery charger</p> <p>29: COM - Set by Modbus</p> <p>30: COP - Controller available</p> <p>31: MAN - Product in manual mode</p>	
23077	5A25	1	<p>Out 9 function (only with 2IN2OUT module #4)</p> <p>0: --- - None</p> <p>1: S1A - Source 1 available</p> <p>2: S2A - Source 2 available</p> <p>3: SCA - Any source available</p> <p>4: CA1 - Source 1 closed</p> <p>5: CA2 - Source 2 closed</p> <p>6: CA0 - Both sources opened</p> <p>7: LO1 - Source 1 closed and available</p> <p>8: LO2 - Source 2 closed and available</p> <p>9: LSC - Load shedding</p> <p>10: FLT - Faults active</p> <p>11: POP - Product operational</p> <p>12: C01 - In 1 copy</p> <p>13: C02 - In 2 copy</p> <p>14: C03 - In 3 copy</p> <p>15: C04 - In 4 copy</p> <p>16: C05 - In 5 copy</p> <p>17: C06 - In 6 copy</p> <p>18: C07 - In 7 copy</p> <p>19: C08 - In 8 copy</p> <p>20: C09 - In 9 copy</p> <p>21: C10 - In 10 copy</p> <p>22: C11 - In 11 copy</p> <p>23: C12 - In 12 copy</p> <p>24: C13 - In 13 copy</p> <p>25: C14 - In 14 copy</p> <p>26: LCK - Product locked</p> <p>27: PTS - Power threshold exceeded</p> <p>28: EES - Battery charger</p> <p>29: COM - Set by Modbus</p> <p>30: COP - Controller available</p> <p>31: MAN - Product in manual mode</p>	



Dec. Address	Hex. Address	Words count	Description	Unit
23078	5A26	1	Out 2 state (only with 2IN2OUT module #1) 0: NO 1: NC	
23079	5A27	1	Out 3 state (only with 2IN2OUT module #1) 0: NO 1: NC	
23080	5A28	1	Out 4 state (only with 2IN2OUT module #2) 0: NO 1: NC	
23081	5A29	1	Out 5 state (only with 2IN2OUT module #2) 0: NO 1: NC	
23082	5A2A	1	Out 6 state (only with 2IN2OUT module #3) 0: NO 1: NC	
23083	5A2B	1	Out 7 state (only with 2IN2OUT module #3) 0: NO 1: NC	
23084	5A2C	1	Out 8 state (only with 2IN2OUT module #4) 0: NO 1: NC	
23085	5A2D	1	Out 9 state (only with 2IN2OUT module #4) 0: NO 1: NC	

## Annexe II - 22. Communication settings

Function 3, 6 and 16 Codes

Dec. Address	Hex. Address	Words count	Description	Unit
23296	5B00	1	MODBUS Address	-
23297	5B01	1	UART Baud Rate 2: 9600 bps 3: 19200 bps 4: 38400 bps	
23298	5B02	1	UART Parity 0: none 1: even 2: odd	
23299	5B03	1	UART Stop bit number 1: 1 stop bit 2: 2 stop bits	
23300	5B04	2	IP Product	-
23302	5B06	2	IP Mask	-
23304	5B08	2	IP Gateway	-
23306	5B0A	1	DHCP Enabled 0: No 1: Yes	
23307	5B0B	8	Product identification	-

## Annexe II - 23. Product counters

Function 3 Codes

Dec. Address	Hex. Address	Words count	Description	Unit
23552	5C00	1	Total Cycles counter	nb of cycles
23553	5C01	1	Total Position 0 switches counter	nb of operations
23554	5C02	1	Total Position I switches counter	nb of operations
23555	5C03	1	Total Position II switches counter	nb of operations
23556	5C04	1	Total switches counter	nb of operations
23557	5C05	1	Cycles in auto mode (including control mode) counter	nb of cycles
23558	5C06	1	Position 0 switches in auto mode (including control mode) counter	nb of operations
23559	5C07	1	Position I switches in auto mode (including control mode) counter	nb of operations
23560	5C08	1	Position II switches in auto mode (including control mode) counter	nb of operations
23561	5C09	1	Total switches in auto mode (including control mode) counter	nb of operations
23562	5C0A	1	Cycles in manual mode counter	nb of cycles
23563	5C0B	1	Position 0 switches in manual mode counter	nb of operations
23564	5C0C	1	Position I switches in manual mode counter	nb of operations
23565	5C0D	1	Position II switches in manual mode counter	nb of operations
23566	5C0E	1	Total switches in manual mode counter	nb of operations
23567	5C0F	1	Cycles in control mode counter	nb of cycles
23568	5C10	1	Position 0 switches in control mode counter	nb of operations
23569	5C11	1	Position I switches in control mode counter	nb of operations
23570	5C12	1	Position II switches in control mode counter	nb of operations
23571	5C13	1	Total switches in control mode counter	nb of operations
23572	5C14	2	Product power on time	s
23574	5C16	1	Start order activation counter	nb of operations
23575	5C17	2	Start order active duration	s
23577	5C19	2	Secondary source presence duration	s
23579	5C1B	2	Secondary source active (i.e. present and switch position at secondary source) duration	s
23581	5C1D	2	Source 1 load supplied duration	s
23583	5C1F	2	Source 2 load supplied duration	s

## Annexe II - 24. Output set

Function 3, 6 and 16 Codes

Dec. Address	Hex. Address	Words count	Description	Unit
23632	5C50	1	OUT1 - Option Module1 Output1 logical state 0: Not active 1: Active	
23633	5C51	1	OUT2 - Option Module1 Output2 logical state 0: Not active 1: Active	
23634	5C52	1	OUT3 - Option Module2 Output1 logical state 0: Not active 1: Active	

Dec. Address	Hex. Address	Words count	Description	Unit
23635	5C53	1	OUT4 - Option Module2 Output2 logical state 0: Not active 1: Active	
23636	5C54	1	OUT5 - Option Module3 Output1 logical state 0: Not active 1: Active	
23637	5C55	1	OUT6 - Option Module3 Output2 logical state 0: Not active 1: Active	
23638	5C56	1	OUT7 - Option Module4 Output1 logical state 0: Not active 1: Active	
23639	5C57	1	OUT8 - Option Module4 Output2 logical state 0: Not active 1: Active	
23640	5C58	1	OP1 - External Board Output logical state 0: Not active 1: Active	
23641	5C59	1	Pulse Output1 logical state 0: Not active 1: Active	
23642	5C5A	1	Pulse Output2 logical state 0: Not active 1: Active	

## Annexe II - 25. Input state

### Function 3 Codes

Dec. Address	Hex. Address	Words count	Description	Unit
23808	5D00	1	In 7 - Option Module1 Input1 logical state 0: Not active 1: Active	
23809	5D01	1	In 8 - Option Module1 Input2 logical state 0: Not active 1: Active	
23810	5D02	1	In 9 - Option Module2 Input1 logical state 0: Not active 1: Active	
23811	5D03	1	In 10 - Option Module2 Input2 logical state 0: Not active 1: Active	
23812	5D04	1	In 11 - Option Module3 Input1 logical state 0: Not active 1: Active	
23813	5D05	1	In 12 - Option Module3 Input2 logical state 0: Not active 1: Active	
23814	5D06	1	In 13 - Option Module4 Input1 logical state 0: Not active 1: Active	
23815	5D07	1	In 14 - Option Module4 Input2 logical state 0: Not active 1: Active	

Dec. Address	Hex. Address	Words count	Description	Unit
23816	5D08	1	In 5 - STO Board Input1 logical state 0: Not active 1: Active	
23817	5D09	1	In 6 - STO Board Input2 logical state 0: Not active 1: Active	
23818	5D0A	1	In 1 - External Display Board Input1 logical state 0: Not active 1: Active	
23819	5D0B	1	In 2 - External Display Board Input2 logical state 0: Not active 1: Active	
23820	5D0C	1	In 3 - External Display Board Input3 logical state 0: Not active 1: Active	
23821	5D0D	1	In 4 - External Display Board Input4 logical state 0: Not active 1: Active	

## Annexe II - 26. Setup pulse and 0/4-20mA option modules

Function 3, 6 and 16 Codes

Dec. Address	Hex. Address	Words count	Description	Unit
23888	5D50	1	OUT 1 pulse output allocation 0: kWh+ 1: kvarh + 2: kVAh 3: kWh - 4: kvarh - 5: Command	
23889	5D51	1	OUT 1 pulse output value 0: 0,1 kWh/kvarh 1: 1 kWh/kvarh 2: 10 kWh/kvarh 3: 100 kWh/kvarh 4: 1000 kWh/kvarh 5: 10000 kWh/kvarh	
23890	5D52	1	OUT 1 pulse output duration 0: 100ms 1: 200ms 2: 300ms 3: 400ms 4: 500ms 5: 600ms 6: 700ms 7: 800ms 8*: 900ms	
23891	5D53	1	OUT 2 pulse output allocation 0: kWh+ 1: kvarh + 2: kVAh 3: kWh - 4: kvarh - 5: Command	

Dec. Address	Hex. Address	Words count	Description	Unit
23892	5D54	1	OUT 2 pulse output value 0: 0,1 kWh/kvarh 1: 1 kWh/kvarh 2: 10 kWh/kvarh 3: 100 kWh/kvarh 4: 1000 kWh/kvarh 5: 10000 kWh/kvarh	
23893	5D55	1	OUT 2 pulse output duration 0: 100ms 1: 200ms 2: 300ms 3: 400ms 4: 500ms 5: 600ms 6: 700ms 7: 800ms 8: 900ms	
23894	5D56	1	Type of analog output OUT 1 0: 0/20 mA 1: 4/20 mA 2: 30 V	
23895	5D57	1	Output allocation analog OUT1 0: U12 (V) 1: U23 (V) 2: U31 (V) 3: V1 (V) 4: V2 (V) 5: V3 (V) 6: I1 (A) 7: I2 (A) 8: I3 (A) 9: In (A) 10: F (Hz) 11: $\sum P$ (W) 12: $\sum Q$ (var) 13: $\sum S$ (VA) 14: $\sum PFL$ (%) 15: $\sum PFC$ (%)	
23896	5D58	1	Value at 0 or 4 mA from analog output OUT 1 (-20000 to +20000)	-
23897	5D59	1	Unit at 0 or 4 mA from analog output OUT1 0: / 1: k 2: M	
23898	5D5A	1	Value at 20 mA from analog output OUT 1 (-20000 to +20000)	-
23899	5D5B	1	Unit at 20 mA from analog output OUT1 0: / 1: k 2: M	
23900	5D5C	1	Type of analog output OUT 2 0: 0/20 mA 1: 4/20 mA 2: 30 V	

Dec. Address	Hex. Address	Words count	Description	Unit
23901	5D5D	1	Output allocation analog OUT2 0: U12 (V) 1: U23 (V) 2: U31 (V) 3: V1 (V) 4: V2 (V) 5: V3 (V) 6: I1 (A) 7: I2 (A) 8: I3 (A) 9: In (A) 10: F (Hz) 11: $\sum P$ (W) 12: $\sum Q$ (var) 13: $\sum S$ (VA) 14: $\sum PFL$ (%) 15: $\sum PFC$ (%)	
23902	5D5E	1	Value at 0 or 4 mA from analog output OUT 2 (-20000 to +20000)	-
23903	5D5F	1	Unit at 0 or 4 mA from analog output OUT2 0: / 1: k 2: M	
23904	5D60	1	Value at 20 mA from analog output OUT 2 (-20000 to +20000)	-
23905	5D61	1	Unit at 20 mA from analog output OUT2 0: / 1: k 2: M	

## Annexe II - 27. Setup custom time

Function 3, 6 and 16 Codes

Dec. Address	Hex. Address	Words count	Description	Unit
24064	5E00	1	Custom1 Mode 0: Not Used 1: For TON 2: For TOF	
24065	5E01	1	Custom1 Validation Type 0: By MODBUS 1: By Input 2: Auto	
24066	5E02	1	Custom1 Frequency 0: Daily 1: Weekly 2: Bi Weekly 3: Monthly 4: Yearly 5: Non Cyclic	
24067	5E03	4	Custom1 Start Time	Date Time
24071	5E07	4	Custom1 End Time	Date Time
24075	5E0B	1	Custom2 Mode 0: Not Used 1: For TON 2: For TOF	
24076	5E0C	1	Custom2 Validation Type 0: By MODBUS 1: By Input 2: Auto	

Dec. Address	Hex. Address	Words count	Description	Unit
24077	5E0D	1	Custom2 Frequency 0: Daily 1: Weekly 2: Bi Weekly 3: Monthly 4: Yearly 5: Non Cyclic	
24078	5E0E	4	Custom2 Start Time	Date Time
24082	5E12	4	Custom2 End Time	Date Time
24086	5E16	1	Custom3 Mode 0: Not Used 1: For TON 2: For TOF	
24087	5E17	1	Custom3 Validation Type 0: By MODBUS 1: By Input 2: Auto	
24088	5E18	1	Custom3 Frequency 0: Daily 1: Weekly 2: Bi Weekly 3: Monthly 4: Yearly 5: Non Cyclic	
24089	5E19	4	Custom3 Start Time	Date Time
24093	5E1D	4	Custom3 End Time	Date Time
24097	5E21	1	Custom4 Mode 0: Not Used 1: For TON 2: For TOF	
24098	5E22	1	Custom4 Validation Type 0: By MODBUS 1: By Input 2: Auto	
24099	5E23	1	Custom4 Frequency 0: Daily 1: Weekly 2: Bi Weekly 3: Monthly 4: Yearly 5: Non Cyclic	
24100	5E24	4	Custom4 Start Time	Date Time
24104	5E28	4	Custom4 End Time	Date Time
24108	5E2C	1	Genset Idle Timeout	Min

## Annexe II - 28. Custom time validate

### Function 6 Codes

Dec. Address	Hex. Address	Words count	Description	Unit
24144	5E50	1	Custom Time1 Validate 1: Validate	
24145	5E51	1	Custom Time2 Validate 1: Validate	
24146	5E52	1	Custom Time3 Validate 1: Validate	
24147	5E53	1	Custom Time4 Validate 1: Validate	

## Annexe II - 28.1. Detailed events

Function 6 and 16 Codes

- Command Zone R1

NOTE: When zone R1 is completed with value 1, zone R2 automatically fills in with the last saved value. At the end of this operation, writing 0xFFFE in zone R1 enables the reading of the next data.

Dec. Address	Hex. Address	Words count	Description	Unit
24320	5F00	1	Action <i>0x0001: Reset read pointer</i> <i>0xFFFE: Get next data</i>	
24321	5F01	1	Filtering action - If not written, no filtering is done <i>To use filtering, entire table should be written in one time with function 16</i> <i>0x00XX: only get events in the form XXyy</i> <i>0xFFFF: no filter</i>	

Function 3 Codes

- Data Zone R2

Dec. Address	Hex. Address	Words count	Description	Unit
24336	5F10	1	record count <i>If record count == 0xFFFF, it means that filtering process is not done now, so the reader has to re-read the table to get the values.</i>	
24337	5F11	1	record size <i>If record size == 0xFFFF, it means that filtering process is not done now, so the reader has to re-read the table to get the values.</i>	nb words
		120	8 * Event data record	



Function 3 Codes

- Data record description

Dec. Address	Hex. Address	Words count	Description	Unit
0	0	1	<p>Event ID</p> <p>0x8000: Power On</p> <p>0x8001: Power Off</p> <p>0x8100: Configuration changed</p> <p>0x8101: Configuration save failed</p> <p>0x8102: Configuration load failed</p> <p>0x8105: Configuration date saved</p> <p>0x8106: Configuration date save failed</p> <p>0x8107: Configuration date read failed</p> <p>0x8110: Configuration calibration read failed</p> <p>0x8300: User reset</p> <p>0x8301: Watchdog reset</p> <p>0x8302: Date resynchronized</p> <p>0xFF00: Software version changed</p> <p>0x0001: Source 1 Lost</p> <p>0x0002: Source 1 comes back</p> <p>0x0003: Source 1 not started (1ST / 2ST)</p> <p>0x0004: Source 1 Undervoltage</p> <p>0x0005: Source 1 Overvoltage</p> <p>0x0006: Source 1 Unbalanced</p> <p>0x0007: Source 1 Underfrequency</p> <p>0x0008: Source 1 Overfrequency</p> <p>0x0009: Source 1 Rotation fault</p> <p>0x000A: Source 1 Neutral fault</p> <p>0x000B: External fault with zero return source 1</p> <p>0x000C: External fault without zero return source 1</p> <p>0x000D: Source 1 Overload</p> <p>0x0101: Source 2 Lost</p> <p>0x0102: Source 2 comes back</p> <p>0x0103: Source 2 not started (2ST)</p> <p>0x0104: Source 2 Undervoltage</p> <p>0x0105: Source 2 Overvoltage</p> <p>0x0106: Source 2 Unbalanced</p> <p>0x0107: Source 2 Underfrequency</p> <p>0x0108: Source 2 Overfrequency</p> <p>0x0109: Source 2 Rotation fault</p> <p>0x010A: Source 2 Neutral fault</p> <p>0x010B: External fault with zero return source II</p> <p>0x010C: External fault without zero return source II</p> <p>0x010D: Source 2 Overload</p> <p>0x0201: Test on load start</p> <p>0x0202: Test on load end</p> <p>0x0203: Test on load failed</p> <p>0x0204: Test off load start</p> <p>0x0205: Test off load end</p> <p>0x0206: Test off load failed</p> <p>0x0207: External order on load start</p> <p>0x0208: External order on load end</p> <p>0x0209: External order on load failed</p> <p>0x020A: External order off load start</p> <p>0x020B: External order off load end</p> <p>0x020C: External order off load failed</p> <p>0x020D: Battery charger start</p> <p>0x020E: Battery charger end</p> <p>0x020F: Unlimited TOF/TON stopped because of communication timeout</p> <p>0x0301: Automatic switch to position 0</p> <p>0x0302: Automatic switch to position I</p> <p>0x0303: Automatic switch to position II</p> <p>0x0304: Manual switch to position 0</p>	

Dec. Address	Hex. Address	Words count	Description	Unit
0	0	1	<p>0x0305: Manual switch to position I  0x0306: Manual switch to position II  0x0307: Remote controlled switch to position 0  0x0308: Remote controlled switch to position I  0x0309: Remote controlled switch to position II  0x030A: Operating Factor Fault  0x030B: Position 0 not reached  0x030C: Position I not reached  0x030D: Position II not reached  0x030E: Unexpected switch to pos 0 when in auto mode  0x030F: Unexpected switch to pos I when in auto mode  0x0310: Unexpected switch to pos II when in auto mode  0x0311: Unexpected switch to pos 0 when in locked mode  0x0312: Unexpected switch to pos I when in locked mode  0x0313: Unexpected switch to pos II when in locked mode  0x0401: Input/Output configuration changed  0x0402: Application/Timers configuration changed  0x0403: Sources (thresholds) configuration changed  0x0404: Communication configuration changed  0x0405: HMI configuration changed  0x0406: Network configuration changed  0x0407: Option modules configuration changed  0x0408: Date/Time configuration changed  0x0409: Default configuration loaded  0x040A: User backup configuration loaded  0x040B: User backup configuration saved  0x040C: Product autoconfiguration requested  0x040D: Product autoconfiguration done  0x040E: Product autoconfiguration failed  0x0501: 1FT - Primary Source fail timer  0x0502: 1RT - Primary Source availability/stabilization timer  0x0504: 1OT - Primary Source return to 0 timer  0x0508: 2FT - Secondary Source fail timer  0x0509: 2RT or 2AT - Secondary Source availability/stabilization timer  0x050A: 2CT - Secondary Source maintain request timer (cooldown timer)  0x050B: 2OT - Secondary Source return to 0 timer  0x050C: 2ST - Secondary Source wait for start timer  0x050D: EET - Secondary Source battery charger timeout  0x050E: EDT - Secondary Source battery charger duration  0x050F: ODT - Dead band timer  0x0510: TON - Test on load duration timer  0x0511: T3T - Test on load end timer  0x0512: TFT - Test off load duration timer  0x0513: E1T - Time before external order on load  0x0514: E3T - Time after external order on load  0x0515: E2T - External order on load duration  0x0516: E5T - Time before external order off load  0x0517: E7T - Time after external order off load  0x0518: E6T - External order off load duration  0x0519: LS_ON - LoadShedding_On Timer  0x051A: LS_OFF - LoadShedding_Off Timer  0x051B: LSB (between 100 ms and 9999 ms)  0x051C: StartGen idle timer  0x0608: Product becomes available  0x0609: Product becomes unavailable  0x060A: Product becomes inhibited  0x060B: Product no more inhibited  0x0701: Source 1 EA+ counter reset  0x0702: Source 1 EA- counter reset  0x0703: Source 1 EQ+ counter reset  0x0704: Source 1 EQ- counter reset  0x0705: Source 1 ES counter reset  0x0706: Source 1 Time meter reset</p>	

Dec. Address	Hex. Address	Words count	Description	Unit
0	0	1	<p>0x0707: Source 2 EA+ counter reset  0x0708: Source 2 EA- counter reset  0x0709: Source 2 EQ+ counter reset  0x070A: Source 2 EQ- counter reset  0x070B: Source 2 ES counter reset  0x070C: Source 2 Time meter reset  0x070D: Start order count reset  0x070E: Start order active duration reset  0x070F: Secondary source duration reset  0x0710: Secondary source active duration reset  0x0711: Source 1 load supplied duration reset  0x0712: Source 2 load supplied duration reset  0x0801: Load shedding request activated  0x0802: Load shedding request deactivated  0x0901: Configuration n°1 active  0x0902: Configuration n°1 validated  0x0903: Configuration n°1 active  0x0904: Configuration n°1 validated  0x0905: Configuration n°1 active  0x0906: Configuration n°1 validated  0x0907: Configuration n°1 active  0x0908: Configuration n°1 validated  0x1001: Read indus area failure  0x1002: Write indus area failure  0x1003: Read serial number failure  0x1004: Write serial number failure  0x1101: Customization load error  0x1102: BET in default  0x1103: BET not present  0x1104: Load context failure  0x1105: StartGen relay fault  0x1106: RTC fault  0x1107: Internal display board detection error  0x1108: External display board detection error  0x1109: 2IN/2OUT option module #1 no more detected  0x110A: 2IN/2OUT option module #2 no more detected  0x110B: 2IN/2OUT option module #3 no more detected  0x110C: 2IN/2OUT option module #4 no more detected  0x110D: External display detection error  0x110E: I2C Fault</p>	
1	1	1	Type 0: State 1: Edge 2: System	
2	2	1	Severity 0: none 1: information 2: warning 3: default	
3	3	1	Satus 0: non active 1: active 2: finished 3: new & checked 4: finished & checked	
4	4	4	Start Date	ms since 1 jan 2000
8	8	2	Duration	ms
10	A	1	Cause	-
11	B	2	Value 1	-
13	D	2	Value 2	-

---

CORPORATE HQ CONTACT:  
SOCOMECSAS  
1-4 RUE DE WESTHOUSE  
67235 BENFELD, FRANCE

---

[www.socomec.com](http://www.socomec.com)



542 001 D - EN - 11/16

 **socomec**  
Innovative Power Solutions